

[atriadesigns.ca](http://atriadesigns.ca)



premier outdoor living • solar shading • cladding products

(604) 428 1818

[sales@atriadesigns.ca](mailto:sales@atriadesigns.ca)

 **NUBES**

MOB

<sup>IT</sup> Copertura All  
Season mobile

<sup>EN</sup> All Season mobile  
roof



 **protezioni.**

Vivere a cielo aperto è un sogno che diventa realtà.

Nubes Mob è la copertura All Season che ridefinisce il modo di vivere gli spazi esterni. Grazie al **sistema di apertura, in versione motorizzata o manuale**, Nubes Mob permette di creare ambienti dinamici che rendono il cielo parte integrante del design.

La **struttura in alluminio**, dall'estetica essenziale e moderna, è progettata per integrare pannelli di grandi dimensioni, a scelta tra **vetro** per una trasparenza raffinata, pannelli in polycarbonato o sandwich, per un risultato blackout dalle elevate performance termodinamiche, per il massimo comfort in ogni stagione.

**Ideale per valorizzare l'ospitalità outdoor sia in ambito residenziale che commerciale**, Nubes Mob si presenta come una soluzione versatile, dalle elevate performance e valore estetico, per una vivibilità outdoor in ogni stagione e protetti da qualsiasi condizione climatica.

Living under the open sky is a dream come true.

Nubes Mob is the All Season roof that redefines the way of experiencing outdoor spaces. Thanks to its **opening system, in motorised or manual versions**, Nubes Mob makes it possible to create dynamic environments that make the sky an integral part of the design.

**The aluminium structure**, with its essential and modern aesthetics, is designed to integrate large panels, choosing between **layered glass** for refined transparency or **innovative panels** with high thermodynamic performance, for the highest comfort in every season.

**Ideal for enhancing terraces, porches or commercial spaces**, Nubes Mob offers a flexible solution with a high aesthetic impact, able to transform any environment into a unique experience for the final customer.



# ▣ NUBES MOB

IT Copertura All Season mobile  
EN All Season mobile roof

5 ANNI DI  
GARANZIA  
Years of  
warranty

 VITERIA  
INOX  
Stainless  
steel screws

 RESISTENTE  
AL SOLE  
Sun-resistant

 RESISTENTE  
AL VENTO  
Wind resistant

 RESISTENTE  
ALLA PIOGGIA  
Rain resistant

 RESISTENTE  
AL CARICO  
Load resistant

 DETRAZIONE  
FISCALE  
Tax deduction



## Info tecniche Technical info

**CERTIFICAZIONE**  
UNI EN1090

**RESISTENZA AL CARICO**

**APERTURA**  
50% - 66% - 75%

**PROFONDITÀ**  
Max 6.000 mm

**LARGHEZZA**  
Senza limiti

**INTERASSE PIANTONI**  
3.500 mm

**PENDENZA**  
10-15%

**STRUTTURA**  
Alluminio estruso, lega primaria, verniciata a polveri epossidiche a base di resina poliestere, resistente ai raggi UV.

**PANNELLI**  
Policarbonato alveolare opale 16 mm  
Pannello sandwich 16 mm  
Vetro stratificato 44.2 trasparente  
Vetro stratificato 53.2 antelio chiaro

**PERNI / VITI / STAFFE / PIASTRE**  
Acciaio Inox  
(staffe e piastre verniciate in tinta)

**MOVIMENTAZIONE**  
manuale con asta  
motorizzata con sistema SOMFY

**CERTIFICATE**  
UNI EN1090

**LOAD RESISTANCE**

**OPENING**  
50% - 66% - 75%

**DEPTH**  
Max 6.000 mm

**WIDTH**  
Unlimited

**WHEELBASE STEERING COLUMNS**  
3.500 mm

**SLOPE**  
10-15%

**STRUCTURE**  
Extruded aluminum, primary alloy, epoxy power-coated with a polyester resin base, UV resistant.

**PANELS**  
Honeycomb polycarbonate 16 mm  
Sandwich panel 16 mm  
44.2 Layered transparent safety glass  
Layered glass 53.2 antelio light

**PINS / SCREWS / BRACKETS / PLATES**  
Stainless steel (brackets and plates painted in the same color)

**HANDLING**  
manual  
motorize with SOMFY system

## Accessori su richiesta Accessories on request

- Illuminazione LED bianco / RGB  
- Tenda ombreggiante:  
tensionata o a nuvoletta  
- Motorizzazione: 66% - 75%

- LED lighting white / RGB  
- Shade blind:  
tensioned or cloud curtain  
- Motorisation: 66% - 75%.

## Colori struttura Structure colours

 **STO1 RAL9010**  
Bianco opaco  
Opaque pure white

 **ST10 RAL7016**  
Grigio antracite opaco  
Opaque anthracite grey

 **PL09**  
Grigio grafite  
Graphite grey

 **STO2 RAL1013**  
Avorio opaco  
Opaque oyster white

 **ST11 RAL7037**  
Grigio polvere opaco  
Opaque dusty grey

 **STO3 RAL8017**  
Marrone opaco  
Opaque chocolate brown

 **PL05**  
Corten (ruggine antico)  
Antique rust

**+5%** Colori optional in cartella  
Optional colors in folder

**+10%** Colori fuori cartella  
Colors out of folder

## Configurazioni Configurations

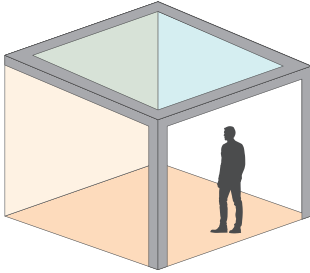

1. **Struttura a parete**  
Structure on a wall

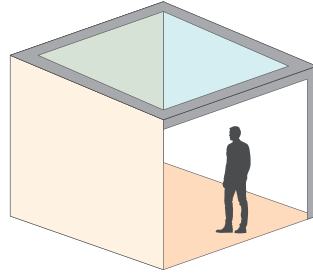

2. **Struttura con parete a sinistra**  
Structure on a left-sided wall

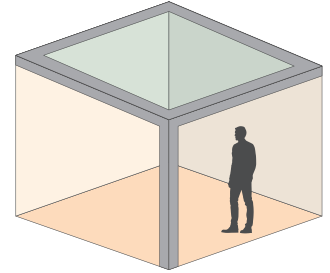

3. **Struttura con parete a destra**  
Structure on a right-sided wall

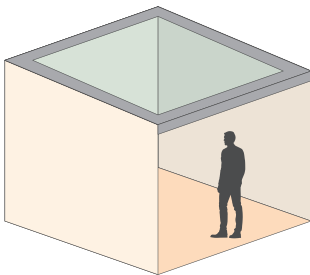

4. **Struttura con due pareti**  
Structure on two walls

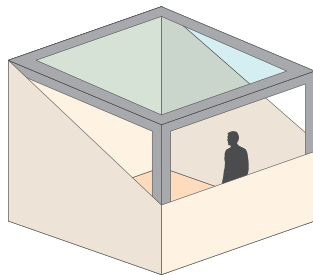

5. **Struttura sulle pareti**  
Structure up on walls

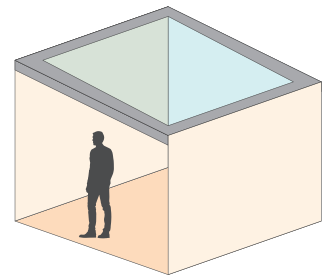

6. **Struttura con parete frontale**  
Structure up walls

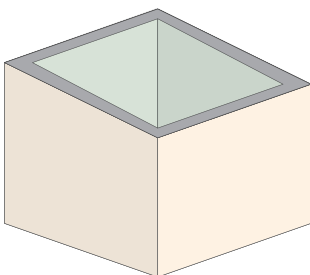

7. **Struttura tra le pareti**  
Structure within walls

### FACILE INSTALLAZIONE

Fissaggio a muro che permette di montare il profilo guida in modo veloce e in sicurezza.

### RESISTENZA

Grazie al sistema modulare, la struttura è in grado di affrontare qualsiasi tipo di condizione atmosferica.

### EASY INSTALLATION

Wall fixing which allows you to fix the guide profile quickly and in total safety.

### RESISTANCE

Thanks to the modular system, the structure is able to cope any kind of weather conditions.

Apertura  
Opening up to

# 50%

Tipo apertura  
Manuale

Pendenza  
da 10% a 15%

Copertura  
- Policarbonato alveolare  
opale 16 mm  
sporgenza max 4.000 mm

- Pannello sandwich  
bianco opaco 16 mm  
sporgenza max 4.000 mm

Opening type  
Manual

Slope  
from 10% a 15%

Roof  
- Multiwall polycarbonate  
opal white 16 mm thick  
overhang max 4.000 mm

- Sandwich panel  
pure white 16 mm thick  
overhang max 4.000 mm

## Dettagli tecnici Technical details

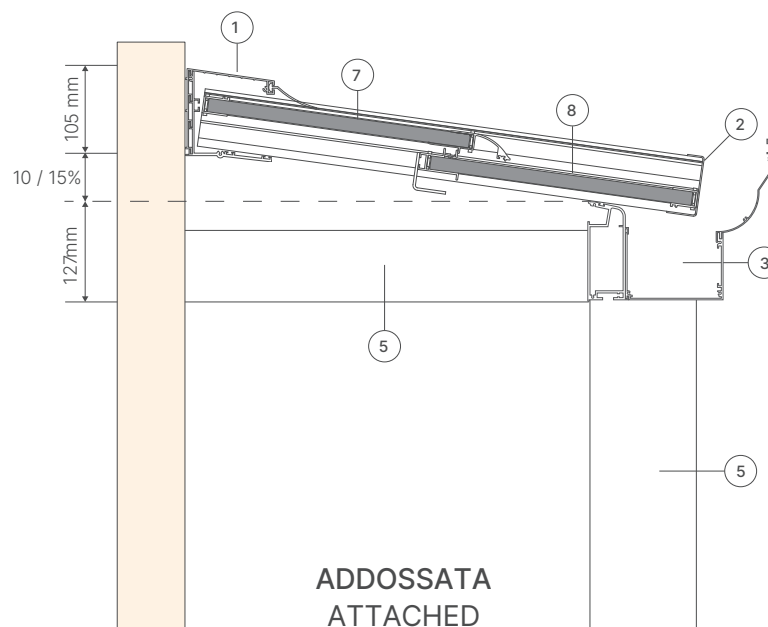
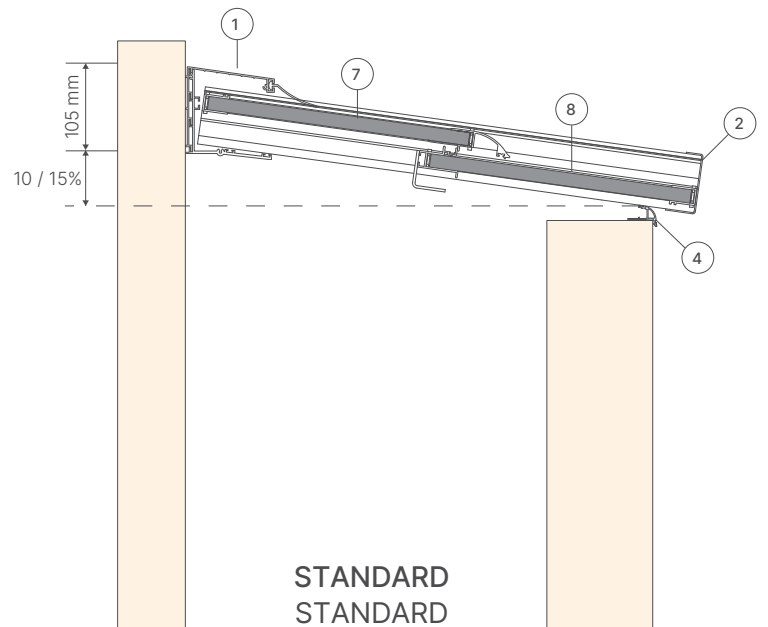

1. Profilo posteriore  
Rear wall profile

2. Guida  
Guide

3. Kit Gronda  
Gutter kit

4. Profilo di ancoraggio  
Anchor profile

5. Piantone / Trave laterale  
Column / lateral beam

6. Staffa muro / kit gronda  
Wall bracket / Gutter kit

7. Pannello fisso  
Fixed panel

8. Pannello mobile  
Sliding panel

## Componenti Components

**1. Profilo posteriore**  
Rear wall profile

**2. Guida**  
Guide

**3. Kit Gronda**  
Gutter kit

**4. Profilo di ancoraggio**  
Anchor profile

**5. Piantone / Trave laterale**  
Column / lateral beam

**6. Staffa muro / kit gronda**  
Wall bracket / Gutter kit

**7. Pannello fisso**  
Fixed panel

**8. Pannello mobile**  
Sliding panel

## Profili Profiles

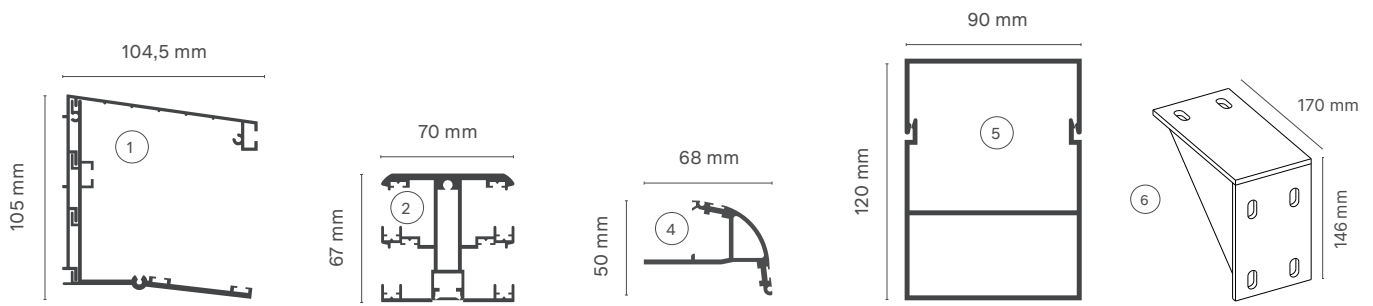

## Kit gronda Gutter kit

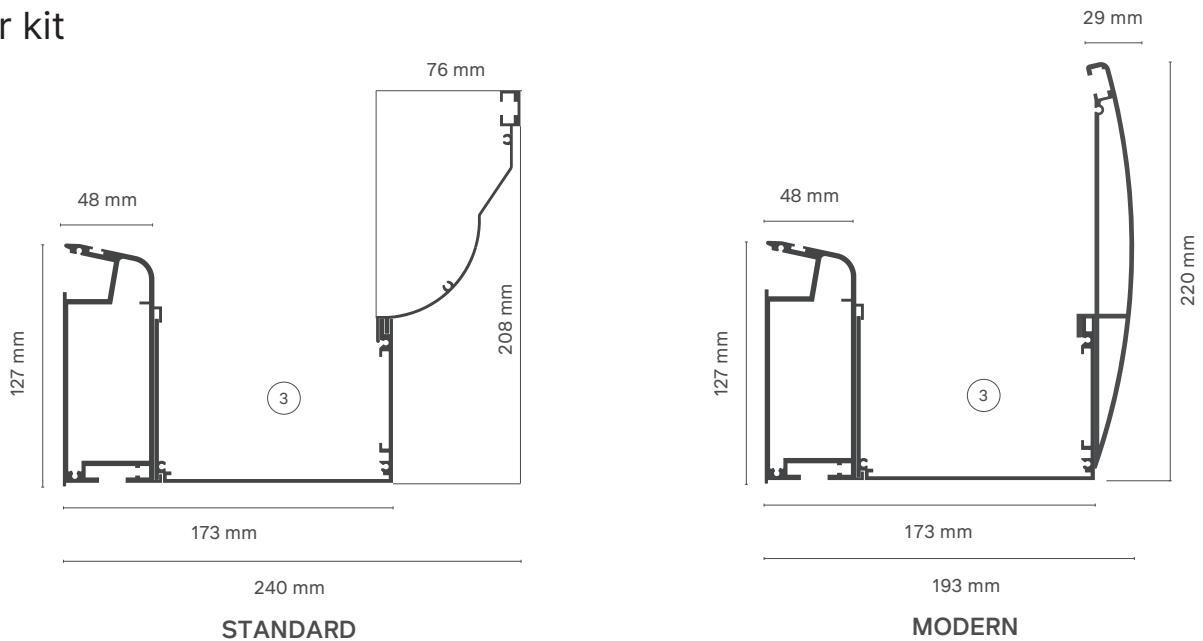

Apertura  
Opening up to

# 66%

**Tipo apertura**  
Manuale o motorizzata

**Pendenza**  
da 10% a 15%

**Copertura**  
- Policarbonato alveolare opale 16 mm sporgenza max 5.000 mm  
- Pannello sandwich bianco opaco 16 mm sporgenza max 5.000 mm

- Vetro stratificato trasparente 44.2 sporgenza max 3.000 mm

**Opening type**  
Manual or motorized

**Slope**  
from 10% a 15%

**Coverage**  
- Multiwall polycarbonate opal white 16 mm thick overhang max 5.000 mm

- Sandwich panel pure white 16 mm thick overhang max 5.000 mm

- Layered safety glass transparent 44.2 overhang max 3.000 mm

## Dettagli tecnici Technical details

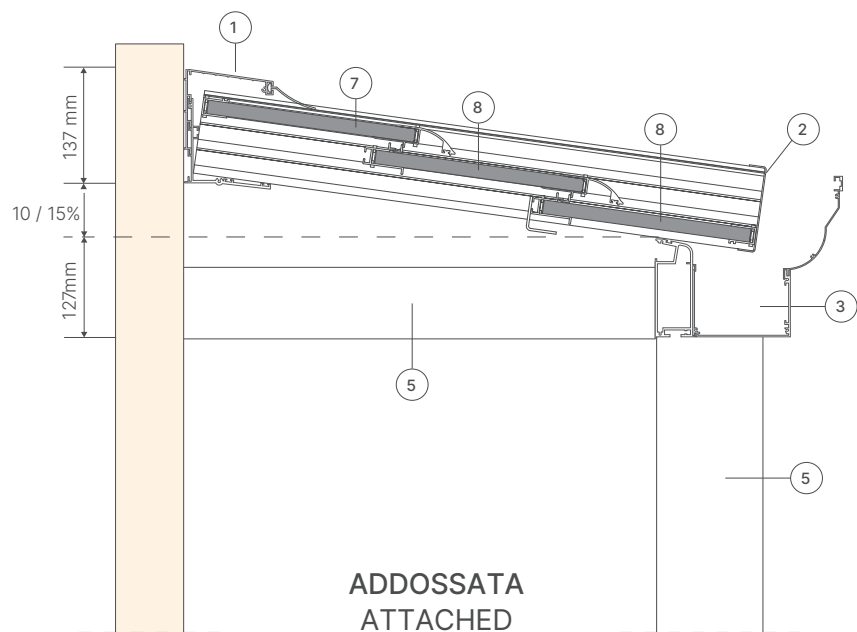
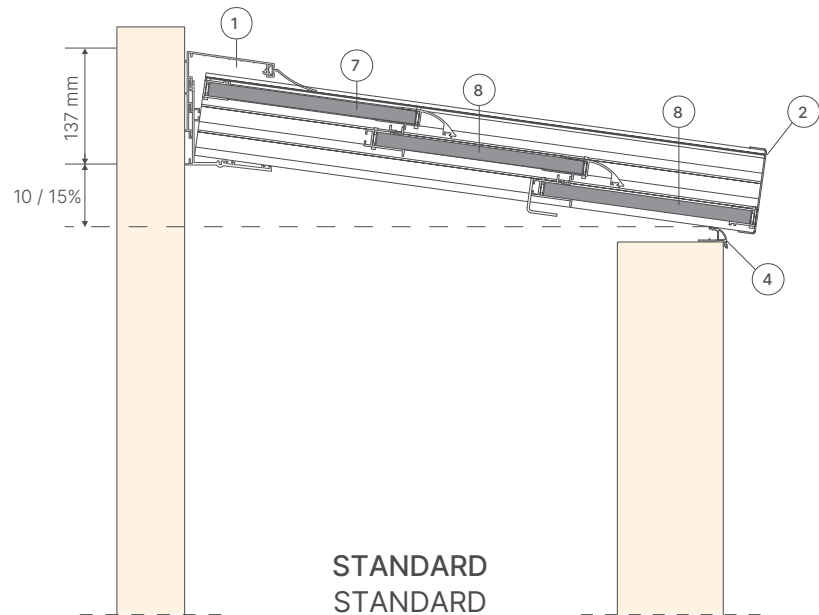

**1. Profilo posteriore**  
Rear wall profile

**2. Guida**  
Guide

**3. Kit Gronda**  
Gutter kit

**4. Profilo di ancoraggio**  
Anchor profile

**5. Piantone / Trave laterale**  
Column / lateral beam

**6. Staffa muro / kit gronda**  
Wall bracket / Gutter kit

**7. Pannello fisso**  
Fixed panel

**8. Pannello mobile**  
Sliding panel

## Componenti Components

**1. Profilo posteriore**  
Rear wall profile

**2. Guida**  
Guide

**3. Kit Gronda**  
Gutter kit

**4. Profilo di ancoraggio**  
Anchor profile

**5. Piantone / Trave laterale**  
Column / lateral beam

**6. Staffa muro / kit gronda**  
Wall bracket / Gutter kit

**7. Pannello fisso**  
Fixed panel

**8. Pannello mobile**  
Sliding panel

## Profili Profiles

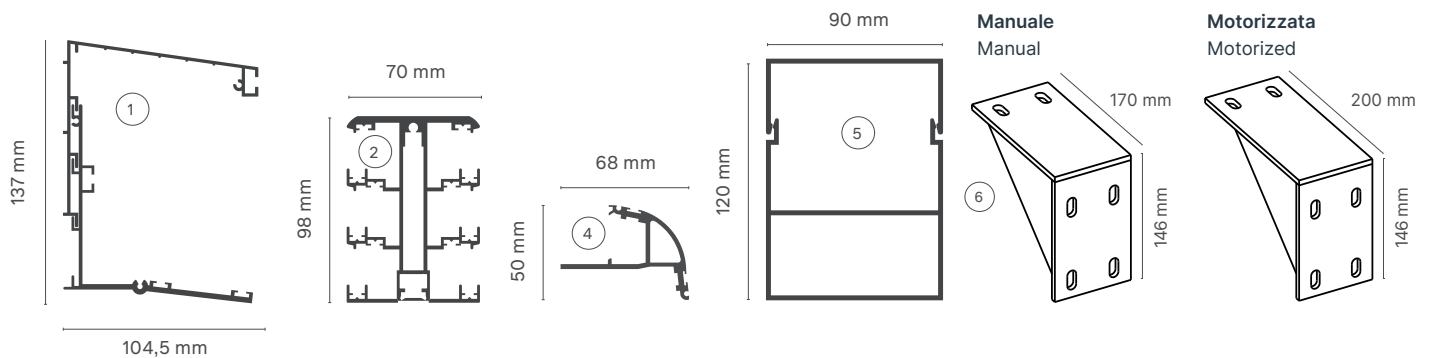

## Kit gronda Gutter kit

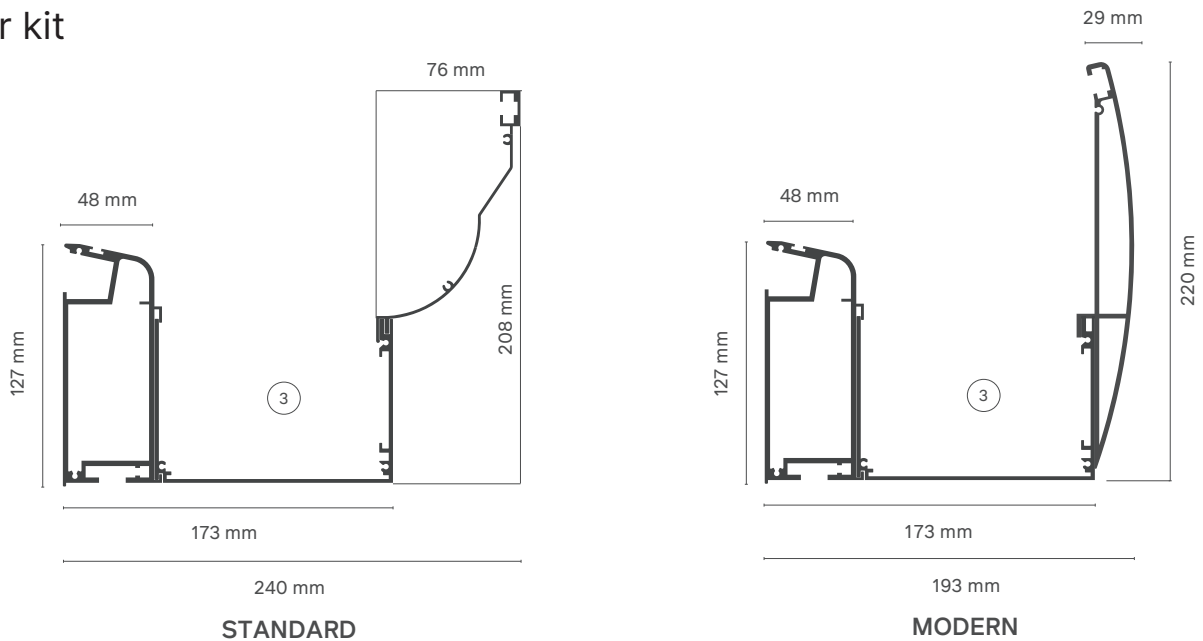

Apertura  
Opening up to

# 75%

**Tipo apertura**  
Manuale o motorizzata

**Pendenza**  
da 10% a 15%

**Copertura**  
- Policarbonato alveolare opale 16 mm sporgenza max 6.000 mm  
- Pannello sandwich bianco opaco 16 mm sporgenza max 6.000 mm

- Vetro stratificato trasparente 44.2 sporgenza max 4.000 mm

**Opening type**  
Manual or motorized

**Slope**  
from 10% a 15%

**Coverage**  
- Multiwall polycarbonate opal white 16 mm thick overhang max 6.000 mm

- Sandwich panel pure white 16 mm thick overhang max 6.000 mm

- Layered safety glass transparent 44.2 overhang max 4.000 mm

## Dettagli tecnici Technical details

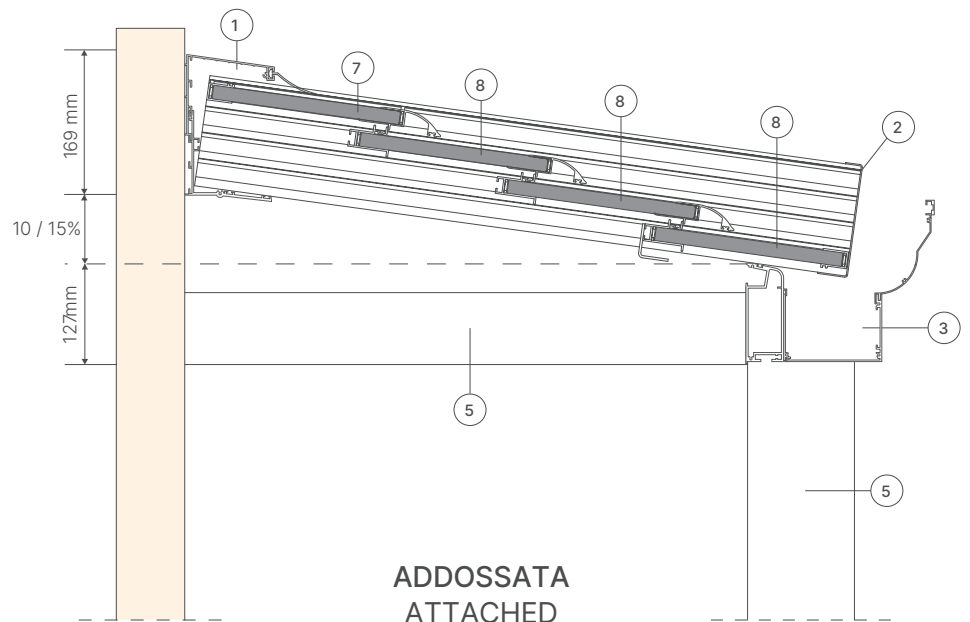
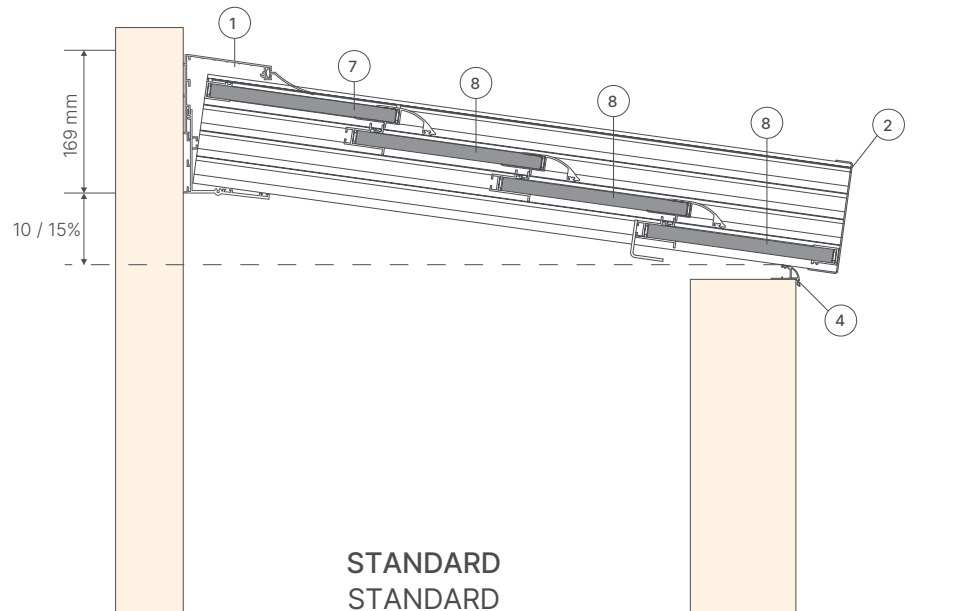

**1. Profilo posteriore**  
Rear wall profile

**2. Guida**  
Guide

**3. Kit Gronda**  
Gutter kit

**4. Profilo di ancoraggio**  
Anchor profile

**5. Piantone / Trave laterale**  
Column / lateral beam

**6. Staffa muro / kit gronda**  
Wall bracket / Gutter kit

**7. Pannello fisso**  
Fixed panel

**8. Pannello mobile**  
Sliding panel

## Componenti Components

**1. Profilo posteriore**  
Rear wall profile

**2. Guida**  
Guide

**3. Kit Gronda**  
Gutter kit

**4. Profilo di ancoraggio**  
Anchor profile

**5. Piantone / Trave laterale**  
Column / lateral beam

**6. Staffa muro / kit gronda**  
Wall bracket / Gutter kit

**7. Pannello fisso**  
Fixed panel

**8. Pannello mobile**  
Sliding panel

## Profili Profiles

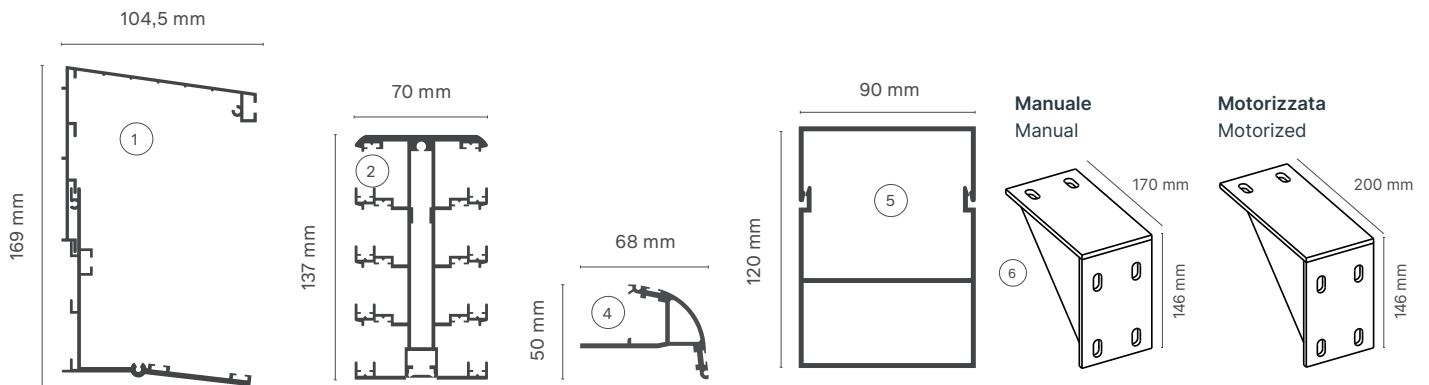

## Kit gronda Gutter kit

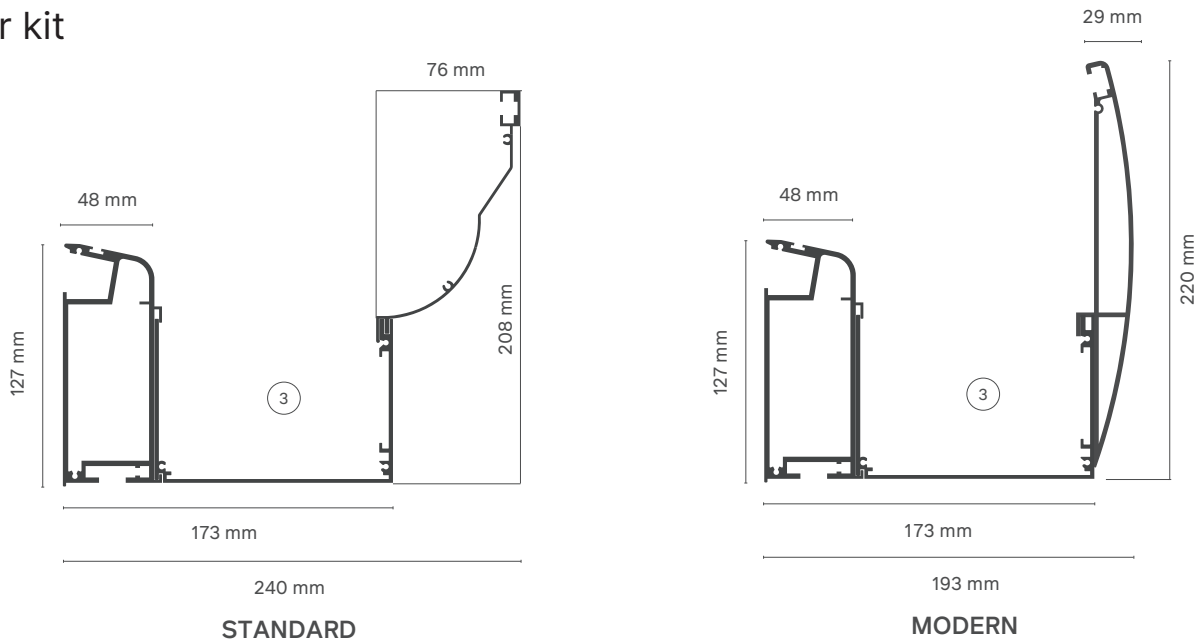

## Staffa di fissaggio per piantone Nubes Mob 50% - 66% - 75% Mounting bracket for the steering column Nubes Mob 50% - 66% - 75%

● **Vista in pianta**  
Plan view

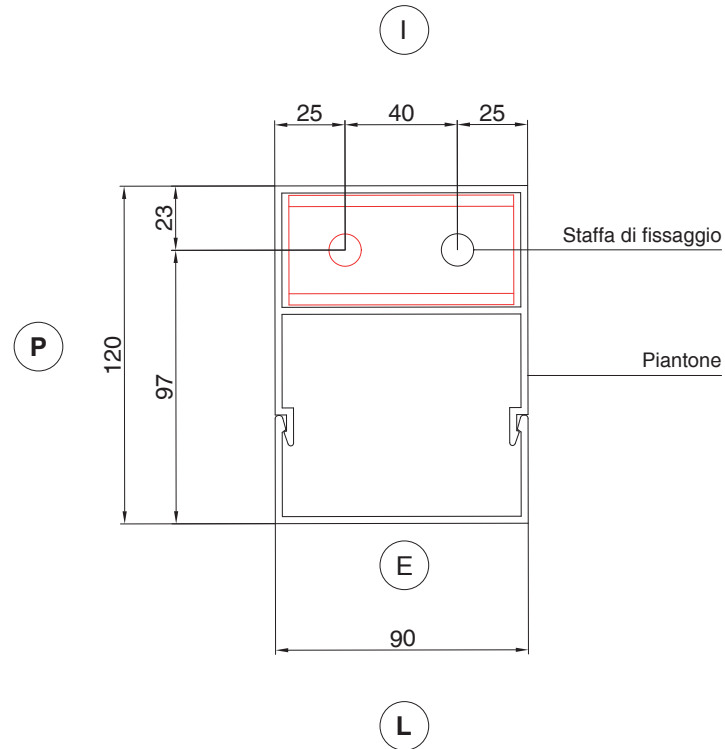

- Ⓜ Lato Interno
  - Ⓜ Lato Esterno
- 
- Ⓜ Profondità copertura
  - Ⓜ Larghezza copertura

● **Vista frontale interna**  
Frontal internal view

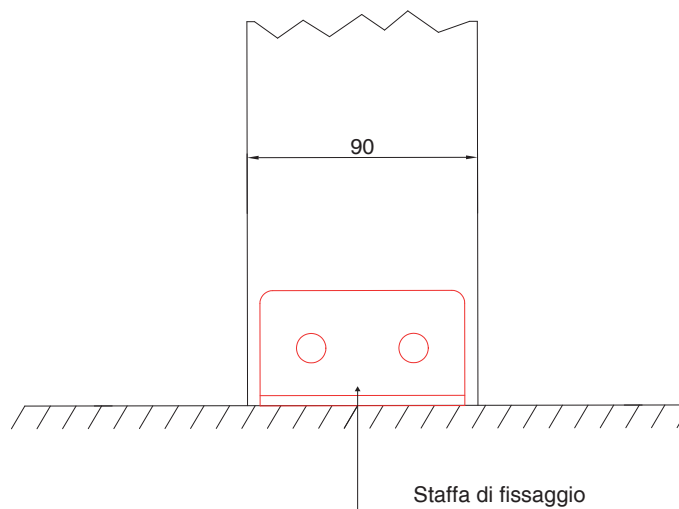

## Tipologia coperture Coverage types

### POLICARBONATO ALVEOLARE MULTIWALL POLYCARBONATE

opale 16 mm  
opal white 16 mm thick

$g^{TOT} = 0.29$

50% max 4.000 mm

66% max 5.000 mm

75% max 6.000 mm

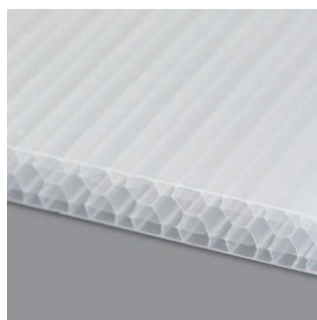

Alveolare / Multiwall

### PANNELLO SANDWICH SANDWICH PANEL

bianco opaco 16 mm  
pure white 16 mm thick

$g^{TOT} = 0.10$

50% max 4.000 mm

66% max 5.000 mm

75% max 6.000 mm

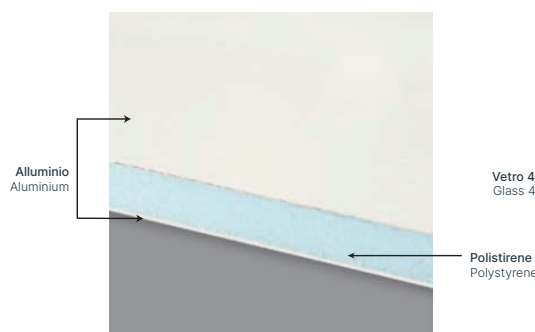

Alluminio / Aluminium  
Polistirene / Polystyrene

### VETRO STRATIFICATO LAYERED GLASS

trasparente 44.2  
transparent 44.2

66% max 3.000 mm

75% max 4.000 mm

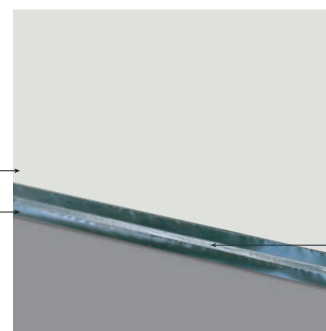

Vetro 4 mm / Glass 4 mm  
PVB 2 mm

### TRASLUCENTE OTTIMA PROTEZIONE DAL SOLE

Struttura a 4 camere d'aria che garantisce ottima coibentazione acustica, termica e protezione dal sole conservando la luce. Pannello leggero, resistente ad urti e carichi, impermeabile. Teste dei pannelli perfettamente sigillate per impedire condensa e infiltrazioni di polvere. Garanzia 10 anni contro ingiallimento, cristallizzazione e rottura da grandine.

### TRANSLUCENT EXCELLENT PROTECTION FROM THE SUN

4 air chambers structure that guarantees excellent acoustic, thermal and sun protection keeping the light. Lightweight panel, impact and load resistance, waterproof. Perfectly sealed panel heads to prevent condensation and dust infiltration. 10 year guarantee against yellowing, crystallization and hail breakage.

### SCHERMANTE ELEVATA SCHERMATURA DALLA LUCE

Struttura interna in polistirene ad alta densità. Pannello sandwich rivestito su entrambi i lati con fogli di alluminio verniciato bianco opaco (RAL 9010) a base poliestere. Essenziale, leggero e resistente, il pannello sandwich garantisce ottima coibentazione termica, elevata schermatura dalla luce e un'eccezionale durata nel tempo.

### SHIELDING HIGH LIGHT SHIELDING

Internal structure in high density polystyrene. Sandwich panel covered on both sides with aluminum sheets painted matt white (RAL 9010) based on polyester. Essential, light and resistant, the sandwich panel guarantees excellent thermal insulation, high shielding from light and exceptional durability.

### TRASPARENTE TOTALE TRASPARENZA

Vetro stratificato a doppia lastra da 4 mm con anima in PVB da 2 mm certificato secondo normative vigenti. La copertura in vetro rappresenta la scelta più elegante per chi desidera vivere lo spazio esterno in totale comfort. Elevata trasparenza e ottima resistenza per rendere sicuro ed esclusivo il vostro spazio.

### TRANSPARENT TOTAL TRANSPARENCY

Layered glass with 4 mm double sheet with 2 mm PVB core certified according to current regulations. The glass cover represents the most elegant choice for those who want to experience the outdoor space in total comfort. High transparency and excellent resistance to make your space safe and exclusive.

