

atriadesigns.ca



premier outdoor living • solar shading • cladding products

(604) 428 1818

sales@atriadesigns.ca

 **NUBES**

FIX

^{IT} Copertura All
Season fissa

^{EN} All Season fixed
roof



Vivere a cielo aperto è un sogno che diventa realtà.

Nubes Fix è la copertura All Season panoramica ed isolante, ideale per estendere la vivibilità degli spazi esterni con design e concretezza.

Nubes Fix è la soluzione ideale per offrire una vivibilità outdoor protetta da qualsiasi condizioni meteo: pioggia, vento e neve con un tetto caratterizzato dalla continuità visiva.

Totalmente personalizzabile in ogni finitura, materiale e dettaglio, la copertura con tetto fisso è progettata per trasformare lo spazio esterno in un luogo unico e accogliente, ideale per essere vissuto in ogni stagione.

Integrazioni eccezionali come le vetrate panoramiche Visio, caratterizzano Nubes Fix di personalità, comfort ed eleganza.

Living under the open sky is a dream come true.

Nubes Fix is the panoramic, insulated All Season roof, ideal for extending the liveability of outdoor spaces with design and practicality.

Nubes Fix is the ideal solution for offering outdoor liveability protected from all weather conditions: rain, wind and snow, with a roof featuring visual continuity.

Fully customisable in every finish, material and detail, the fixed roof is designed to transform outdoor spaces into unique and welcoming places, ideal for enjoying in every season.

Exceptional additions such as Visio panoramic glass walls give Nubes Fix personality, comfort and elegance.



▣ NUBES FIX

IT Copertura All Season fissa
EN All Season fixed roof

5 ANNI DI
GARANZIA
Years of
warranty

 VITERIA
INOX
Stainless
steel screws

 RESISTENTE
AL SOLE
Sun-resistant

 RESISTENTE
AL VENTO
Wind resistant

 RESISTENTE
ALLA PIOGGIA
Rain resistant

 RESISTENTE
AL CARICO
Load resistant

 DETRAZIONE
FISCALE
Tax deduction



Info tecniche Technical info

CERTIFICAZIONE
UNI EN1090

RESISTENZA AL CARICO
Fino a 100 kg/m²

PROFONDITÀ
Max 6.000 mm

LARGHEZZA
Senza limiti

INTERASSE PIANTONI
3.500 mm

PENDENZA
5-15%

STRUTTURA
Alluminio estruso, lega primaria, verniciata a polveri epossidiche a base di resina poliestere, resistente ai raggi UV.

PANNELLI
Policarbonato alveolare 16 mm
Pannello sandwich 16-55-82 mm
Vetro stratificato trasparente 44.2

PERNI / VITI / STAFFE / PIASTRE
Acciaio Inox
(staffe e piastre verniciate in tinta)

CERTIFICATE
UNI EN1090

LOAD RESISTANCE
Up to 100 kg/m²

DEPTH
Max 6.000 mm

WIDTH
Unlimited

WHEELBASE STEERING COLUMNS
3.500 mm

SLOPE
5-15%

STRUCTURE
Extruded aluminum, primary alloy, epoxy power-coated with a polyester resin base, UV resistant.

PANELS
Honeycomb polycarbonate 16 mm
Sandwich panel 16-55-82 mm
Transparent layered glass 44.2

PINS / SCREWS / BRACKETS / PLATES
Stainless steel
(brackets and plates painted in the same color)

Accessori su richiesta Accessories on request

- Illuminazione LED bianco / RGB
- Tenda ombreggiante

- LED lighting white / RGB
- Shade blind

Colori struttura Structure colours

 **STO1 RAL9010**
Bianco opaco
Opaque pure white

 **STO3 RAL8017**
Marrone opaco
Opaque chocolate brown

 **ST11 RAL7037**
Grigio polvere opaco
Opaque dusty grey

 **STO2 RAL1013**
Avorio opaco
Opaque oyster white

 **ST10 RAL7016**
Grigio antracite opaco
Opaque anthracite grey

 **PL09**
Grigio grafite
Graphite grey

 **PL05**
Corten (ruggine antico)
Antique rust

+5% **Colori optional in cartella**
Optional colors in folder

+10% **Colori fuori cartella**
Colors out of folder

Configurazioni Configurations

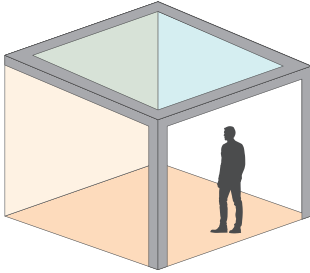

1. **Struttura a parete**
Structure on a wall

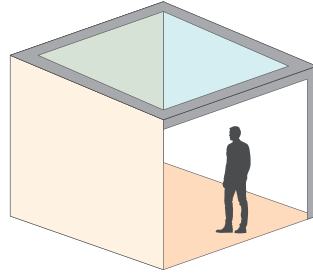

2. **Struttura con parete a sinistra**
Structure on a left-sided wall

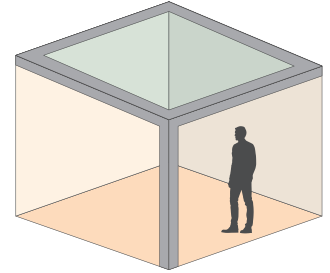

3. **Struttura con parete a destra**
Structure on a right-sided wall

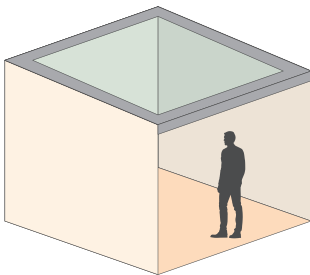

4. **Struttura con due pareti**
Structure on two walls

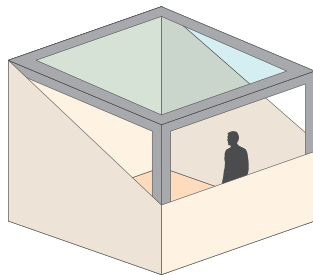

5. **Struttura sulle pareti**
Structure up on walls

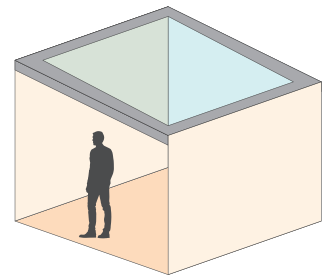

6. **Struttura con parete frontale**
Structure up walls

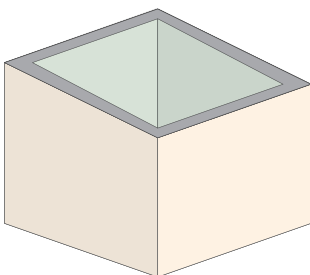

7. **Struttura tra le pareti**
Structure within walls

FACILE INSTALLAZIONE

Fissaggio a muro che permette di montare il profilo guida in modo veloce e in sicurezza.

RESISTENZA

Grazie al sistema modulare, la struttura è in grado di affrontare qualsiasi tipo di condizione atmosferica.

EASY INSTALLATION

Wall fixing which allows you to fix the guide profile quickly and in total safety.

RESISTANCE

Thanks to the modular system, the structure is able to cope any kind of weather conditions.

Copertura Roof

Pendenza
da 5% a 15%

Copertura
Policarbonato alveolare
opale 16 mm
sporgenza max 6.000 mm

Pannello sandwich
opaco 16 mm
sporgenza max 6.000 mm

Pannello sandwich
opaco 55 mm **autoportante**
sporgenza max 4.000 mm

Pannello sandwich
opaco 55 mm **con guida rinforzata**
sporgenza max 5.000 mm

Pannello sandwich
opaco 82 mm **autoportante**
sporgenza max 6.000 mm

Vetro stratificato trasparente
44.2 sporgenza max 4.000 mm

Slope
from 5% to 15%

Roof
Honeycomb polycarbonate
opal white 16 mm thick
overhang max 6000 mm

Sandwich matt panel
16 mm overhang max 6.000 mm

Sandwich matt panel
55 mm **self-supporting**
overhang max 4.000 mm

Sandwich matt panel
55 mm **reinforced guide**
overhang max 5.000 mm

Sandwich matt panel
82 mm **self-supporting**
overhang max 6.000 mm

Transparent layered
glass 44.2
overhang max 4.000 mm

Dettagli tecnici Technical details

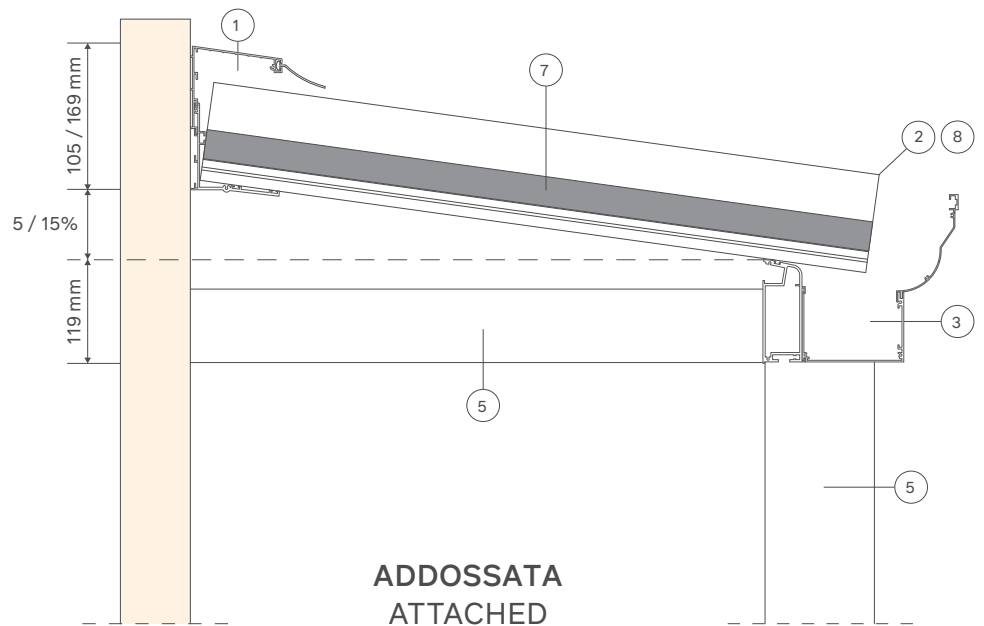
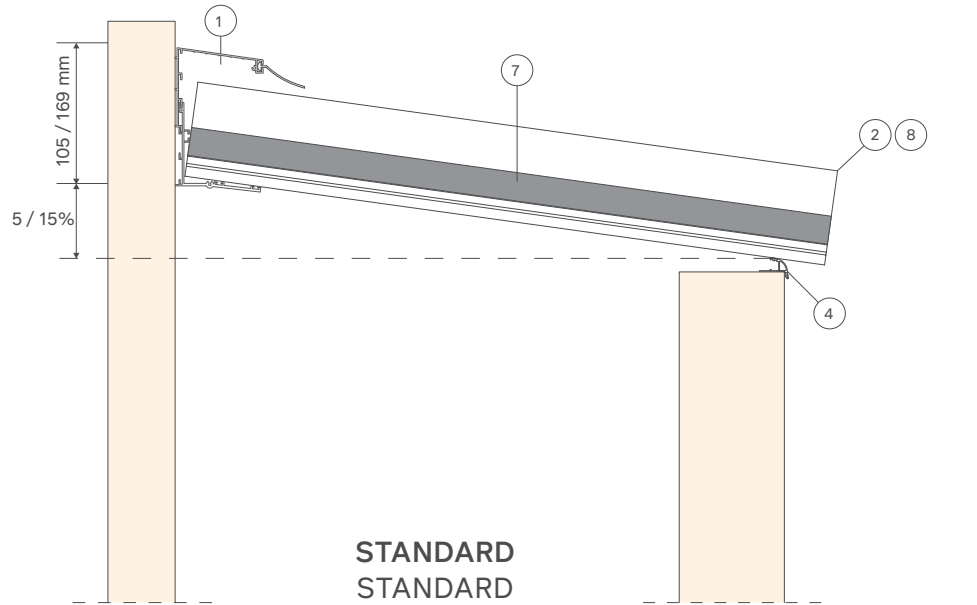

Componenti Components

1. Profilo posteriore
Rear wall profile

2. Guida a T
"T" Guide

3. Kit Gronda
Gutter kit

4. Profilo di ancoraggio
Anchor profile

5. Piantone / Trave laterale
Column / lateral beam

6. Staffa muro / kit gronda
Wall bracket / Gutter kit

7. Pannello fisso
Fixed panel

8. Guida rinforzata
Reinforced guide

Profili Profiles

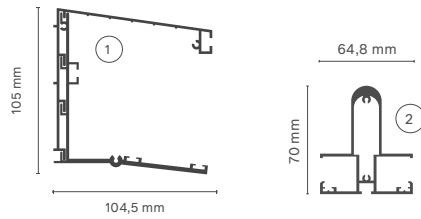

▶ **policarbonato alveolare per sporgenza fino a 4.000 mm**
Honeycomb polycarbonate for protrusion up to 4.000 mm

▶ **pannello sandwich 55 mm autoportante**
55 mm self-supporting sandwich panel

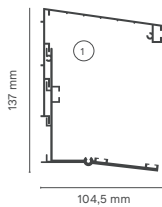

▶ **pannello sandwich 82 mm autoportante**
82 mm sandwich panel self-supporting version

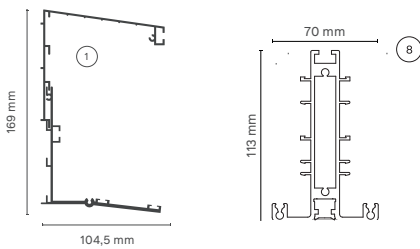

▶ **policarbonato alveolare per sporgenza da 4.000 mm fino a 6.000 mm**
honeycomb polycarbonate for projection up 4,000 to 6,000 mm

▶ **vetro stratificato 44.2**
44.2 layered glass

▶ **pannello sandwich 16 - 55 mm**
sandwich panel 16 - 55 mm

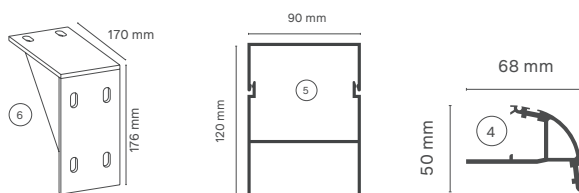

Kit gronda Gutter kit

● standard

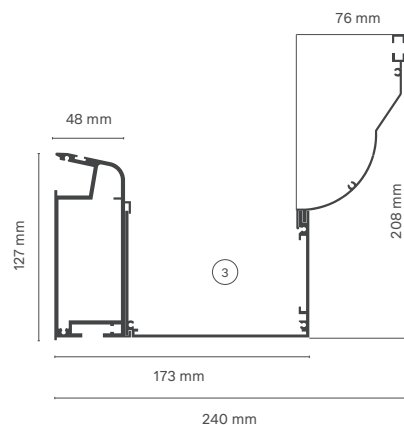

● modern

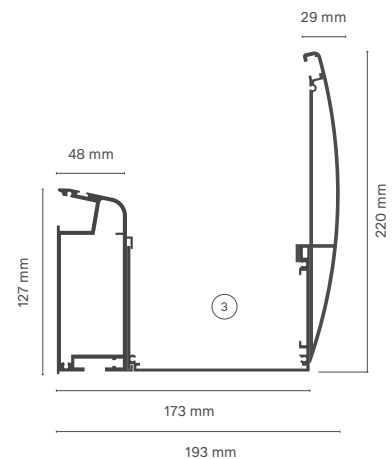

Staffa di fissaggio per piantone Mounting bracket for the steering column

● **Vista in pianta**
Plan view

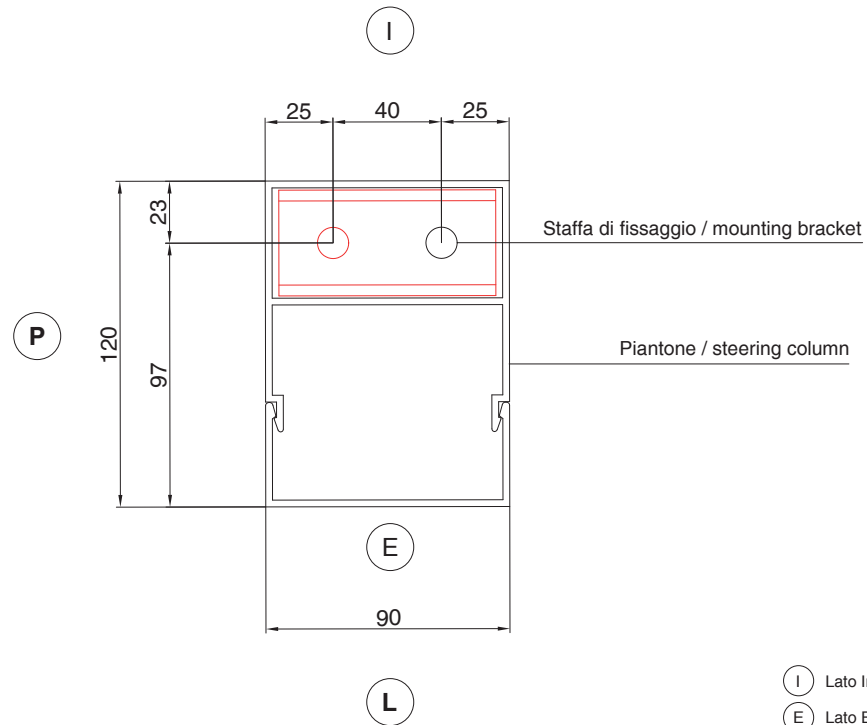

- Ⓢ Lato Interno / Internal side
 - Ⓢ Lato Esterno / External side
-
- Ⓢ Profondità copertura / Depth of roof
 - Ⓢ Larghezza copertura / Width of roof

● **Vista frontale interna**
Frontal internal view

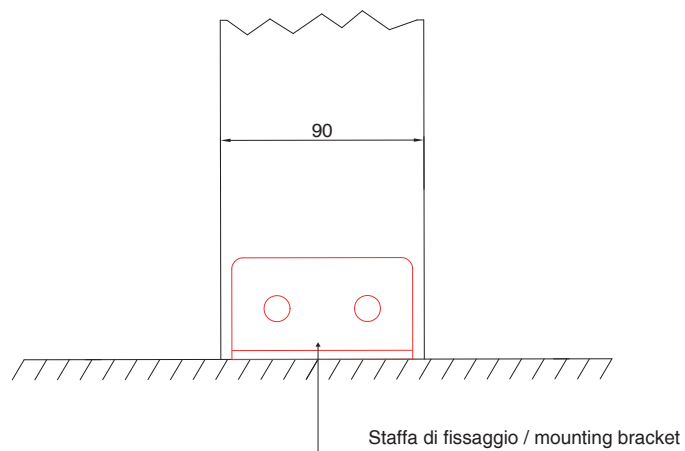

Tipologia pannelli copertura Type of roof panels

Policarbonato alveolare Honeycomb polycarbonate

- opale 16 mm
opal white 16 mm

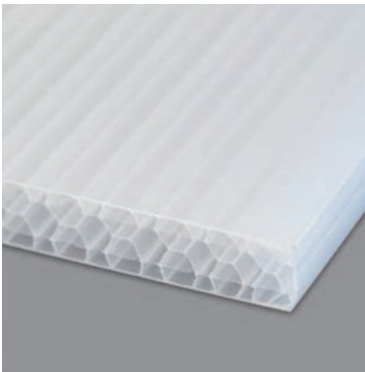

Alveolare / Honeycomb

Pannello sandwich sandwich panel

- autoportante, bianco opaco 55-82 mm
self-supporting, pure white 55-82 mm
- bianco opaco 16 mm
pure white 16 mm

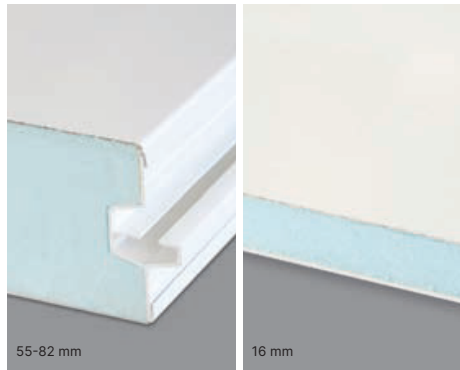

Alluminio / Aluminium
Polistirene / Polystyrene

Vetro stratificato Layered glass

- trasparente 44.2
transparent 44.2

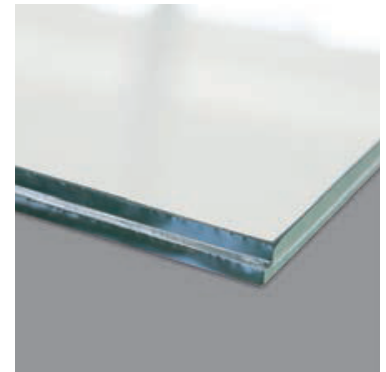

Vetro 4 mm / Glass 4 mm
PVB 2 mm

Traslucente Ottima protezione dal sole

Struttura a 4 camere d'aria che garantisce ottima coibentazione acustica, termica e protezione dal sole conservando la luce. Pannello leggero, resistente ad urti e carichi, impermeabile. Teste dei pannelli perfettamente sigillate per impedire condensa e infiltrazioni di polvere. Garanzia 10 anni contro ingiallimento, cristallizzazione e rottura da grandine.

Translucent Excellent sun-protection

4 air chambers structure that guarantees excellent acoustic, thermal and sun protection keeping the light. Lightweight panel, impact and load resistance, waterproof. Perfectly sealed panel heads to prevent condensation and dust infiltration. 10 year guarantee against yellowing, crystallization and hail breakage.

Schermante Elevata schermatura dalla luce

Struttura interna in polistirene ad alta densità. Pannello sandwich rivestito su entrambi i lati con fogli di alluminio verniciato bianco opaco (RAL 9010) a base poliestere. Essenziale, leggero e resistente, il pannello sandwich garantisce ottima coibentazione termica, elevata schermatura dalla luce e un'eccezionale durata nel tempo.

Shielding High light shielding

Internal structure in high density polystyrene. Sandwich panel covered on both sides with aluminum sheets painted matt white (RAL 9010) based on polyester. Essential, light and resistant, the sandwich panel guarantees excellent thermal insulation, high shielding from light and exceptional durability.

Trasparente Totale trasparenza

Vetro stratificato a doppia lastra da 4 mm con anima in PVB da 2 mm certificato secondo normative vigenti. La copertura in vetro rappresenta la scelta più elegante per chi desidera vivere lo spazio esterno in totale comfort. Elevata trasparenza e ottima resistenza per rendere sicuro ed esclusivo il vostro spazio.

Transparent Total transparency

Layered glass with 4 mm double sheet with 2 mm PVB core certified according to current regulations. The glass cover represents the most elegant choice for those who want to experience the outdoor space in total comfort. High transparency and excellent resistance to make your space safe and exclusive.

