

atriadesigns.ca



(604) 428 1818
sales@atriadesigns.ca

CAMARGUE® SKYE

PRODUCT INFORMATION



TABLE OF CONTENTS

Description	3
Benefits	4
Design	4
Quality	5
Customisation	7
Comfort	7
Technical details	8
Standard configuration	9
Overview stacked package and opening roof	10
Camargue Skye weight	11
Camargue Skye snow load	12
Accessories	13
Certificates & testing	15
Configuration	16
Type	16
Construction method	19
Columns	21
Profiles	23
Blade orientation	24
Mounting bases	25
Mounting bases	26
Water drainage	27
Other tools	28









SUN PROTECTION VENTILATING WATER RESISTANT RETRACTABLE

DESCRIPTION

Modular aluminium patio cover with rotating and sliding blades and integrated side elements.

- Fully retractable roof
- Durable rotation and sliding technology thanks to patented S-drive technology
- All accessories are beautifully integrated
- Can be joined in multiple parts in the span or pivot
- Protection from the sun, rain and wind
- Can be controlled using io, RTS or the Renson® Connect App*

 <p>One roof section</p>	 <p>blades closed</p>		
 <p>blades retracted</p>			

* Full operation via the Renson Connect app is only possible in countries where Somfy io is legally allowed. In countries where only Somfy RTS is allowed, operation of Fixscreen, Led-lighting and heating is done via separate hand transmitter.

BENEFITS

Design



1 THE ROOF IS COMPLETELY FLAT WHEN CLOSED

2 MINIMAL GAPS BETWEEN THE BLADES

3 MODULAR DESIGN

Expandable to include multiple roof sections, even after initial installation. The structure can be endlessly expanded on both the span and pivot side to cover large surface areas.

4 INVISIBLE SCREWS

Create an elegant and sleek structure

5 THE FABRIC ROLLER TUBE IS FULLY INTEGRATED INTO THE STRUCTURE

INNOVATION

No visible screen head box disrupting the aesthetic

6 THE BOTTOM BAR DISAPPEARS INTO THE HEAD BOX

7 INTEGRATED MOTOR FORMS A STUNNING MINIMALIST DESIGN, WITHOUT A MOTOR DISRUPTING THE AESTHETIC

8 INTEGRATED FIXSCREEN SIDE GUIDING CHANNELS IN THE COLUMNS

INNOVATION

Full aesthetic integration with the Camargue structure

Quality



1 'TRAIN' SYSTEM (OTHER BRANDS ON THE MARKET)

Only the first blade [the locomotive] is driven, and all other blades [the carriages] are passively pulled along

2 SYNCHRONISED DRIVE ON BOTH SIDES OF THE BLADES

Even with an asymmetric load, the roof will open and close in one smooth movement

3 RENSON® S-DRIVE

INNOVATION

Driven by a spindle that evenly distributes traction across all blades



4 SPINDLE FOR SLIDING BLADES

INNOVATION

5 TROLLEYS ON RAILS ENSURE SMOOTH AND STABLE MOVEMENT

Each blade is driven individually

6 HEXAGONAL AXLE FOR ROTATING BLADES

7 STRONG, DOUBLE-WALLED BLADES CAN HANDLE HEAVY SNOW LOADS

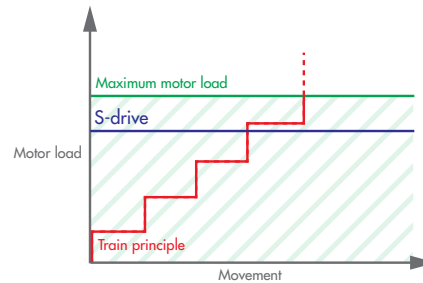



8 UNIQUE END CAPS

provide a solid corner connection and perfect water drainage

9 NO HOLES IN THE WATER CHANNEL

An additional chamber means no holes need to be drilled in the water channel when affixing side inserts.

10 WELDED ALUMINIUM DRIPS, POWDER COATED TO MATCH THE COLOUR OF THE ROOF BLADES

11 INTEGRATED WATER DRAINAGE WITH LARGE FLOW RATE

Through the wide blade gutters, water flows towards the gutters (with diffusers to counter splashing) before being drained via PVC drainpipes integrated into the columns.

Customisation

1 WIDEST RANGE OF SIDE INFILLS

2 BACK ORDERS POSSIBLE

3 ACCESSORIES

For more information about the possible accessories, see the 'Accessories' section and/or the product information for the various accessories.

Comfort

1 MAXIMUM NATURAL LIGHT

The blades not only rotate through 135°, they can also be fully retracted

2 SPECIALLY DEVELOPED GUTTER BORDER INNOVATION

Prevents your patio and furniture from getting wet when the blades are opened following a rain shower

3 SILENT AND SOFT CLOSING MECHANISM BY ADDING A BRUSH TO THE BLADES

4 QUICK INSTALLATION

Thanks to maximum pre-assembly and the modular structure of the various junctions



TECHNICAL DETAILS



Dimensions	
Span	Min. 1800* mm - max. 4500 mm
Pivot	Min. 3250 - max. 6200 mm
Passage height	Min. 415 mm - max. 2800 mm
Total height with blades closed	Passage height + 260 mm
Total height with blades 90° open	Passage height + 355 mm
Minimum height required when installed under a roof overhang	Passage height + 365 mm
Blade rotation	Max. 135°
Minimum number of water drainage points < 16 m ²	1
Minimum number of water drainage points > 16 m ²	2**
Operating methods	
Renson® Connect App***	✓
Renson Connect App + transmitter ****	✓
Home automation ready	✓

* Smaller dimensions [span min. 1800 mm and pivot min. 1256 mm] possible by special request to pre-sales - drawing office.

** Please note: If only one column is used, the water drainage capacity will be limited to 0.025 l/m².s [90 l/h]

*** Full operation via Renson Connect app, for countries where Somfy io is legally allowed.

**** For countries where only Somfy RTS is allowed, operation of the roof is via Renson Connect app and operation of LED and/or heating is via hand transmitter.

Electrical bladed roof drive

Parameters	Value
Supply voltage	230 Volt AC, 50 Hz
Transformer current range	0 - 3.5 Ampère
Transformer power	2 x 150 W
Motor voltage	24 Volt DC
Motor nominal current	6 Ampère
Protection rating	IP 65
Maximum running time with continuous use	Approx. 10 minutes
Automatic	16 A Curve C



Standard configuration

Structure

- Free-standing or façade mounted (against whole wall or partial connection)
- Standard mounting bases (visible, invisible or cast)
- Custom span, pivot and passage height with mm precision
- Patented S-Drive motor

Finish

- Seaside Quality A
- Monocolour or dual colour according to Renson® standard colours
- Integrated water drainage (incl. PVC drainage pipes and anti-splash diffusers in the gutter)

Overview stacked package and opening roof

Pivot in mm	Number of blades	Thickness package in mm	Opening roof in mm
3250	13	768	2125
3410	14	818	2260
3625	15	868	2425
3840	16	918	2590
4055	17	968	2755
4270	18	1018	2920
4485	19	1068	3085
4700	20	1118	3250
4915	21	1168	3415
5130	22	1218	3580
5345	23	1268	3745
5560	24	1318	3910
5775	25	1368	4075
5990	26	1418	4240
6200	26	1463	4270

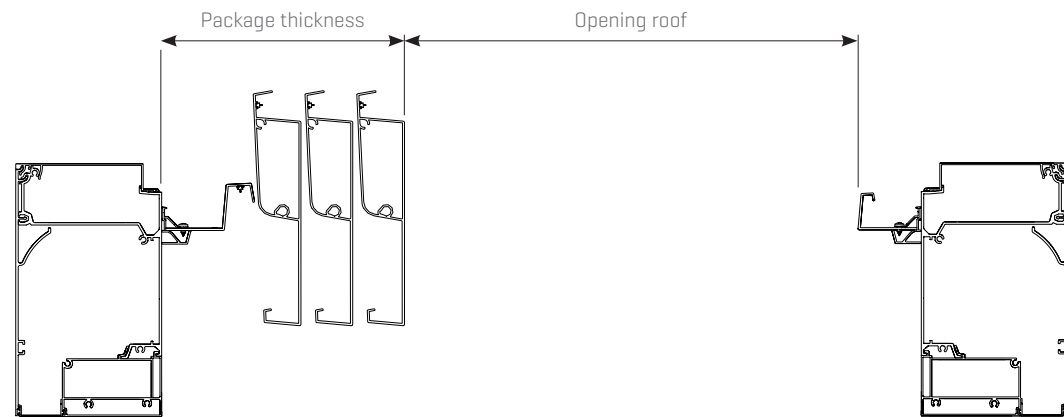

Camargue Skye weight

		Total weight [kg] of entire Camargue Skye								
		Span								
Pivot	Dimensions in mm	# blades	1500	2000	2500	3000	3500	4000	4500	
		3250	13	235	268	300	333	366	398	431
		3410	14	245	279	313	347	382	416	450
		3625	15	257	292	328	364	400	435	471
		3840	16	268	306	343	380	418	455	492
		4055	17	280	319	358	397	436	475	514
		4270	18	292	333	373	414	454	494	535
		4485	19	304	346	388	430	472	514	556
		4700	20	316	360	403	447	490	534	577
		4915	21	328	373	418	463	508	553	598
		5130	22	340	386	433	480	526	573	620
		5345	23	352	400	448	496	544	593	641
	5560	24	364	413	463	513	563	612	662	
	5775	25	375	427	478	529	581	632	683	
	5990	26	387	440	493	546	599	652	704	
	6200	26	396	449	502	555	607	660	713	

The table above shows the weight of the Skye frame; the weight of the columns and mounting bases is not included. Each column in the configuration adds an extra weight of 5.7 kg/column metre.

Standard mounting base weight

- invisible mounting base: 2050 g
- cast mounting base: 3590 g
- visible mounting base: 4450 g
- visible [corner]: 3085 g

Reinforced mounting base weight

- invisible mounting base: 7240 g
- visible mounting base: 11285 g
- visible [corner]: 9010 g

Camargue Skye snow load

		Maximum snow load Camargue Skye [kg/m ²]										
		Span										
Pivot	Dimensions in mm	2000	2250	2500	2750	3000	3250	3500	3750	4000	4250	4500
		4000	866	563	385	273	199	149	113	87	68	53
	4250	866	563	385	273	199	149	113	87	68	53	41
	4500	866	563	385	273	199	149	113	87	68	53	41
	4750	862	563	385	273	199	149	113	87	68	53	41
	5000	727	563	385	273	199	149	113	87	68	53	41
	5250	619	536	385	273	199	149	113	87	68	53	41
	5500	530	459	385	273	199	149	113	87	68	53	41
	5750	457	395	348	273	199	149	113	87	68	53	41
	6000	396	342	301	268	199	149	113	87	68	53	41
	6200	354	306	269	240	199	149	113	87	68	53	41



ACCESSORIES



Comfort pack		Back order
Fixscreen + Lineo Led	-	-
Side infills		
Integrated Fixscreen	✓	✓
Algarve Fixscreen	-	-
Lapure Fixscreen	-	-
Triangle	-	-
Loggia® sliding door	✓	✓
Loggiascreen Canvas sliding door	✓	✓
Glass sliding panels*	✓	✓
Linius wall*	✓	✓
Linarte wall*	✓	✓
Outdoor curtains	✓	✓
Comfort		
Lighting		
Lineo Led	-	-
UpDown Led	✓	✓
Colomno Led	✓	-
Lapure Led	-	-
Comfort and design		
Beam Heat & Sound**	✓	✓
Lineo Luce	-	-
Lineo Fix	-	-
Lineo Heat	-	-
Waterproof wall mounting	-	-
Protecto protective profile	-	-
Automation		
Wind sensor***	✓	✓
Rain sensor	✓	✓
Sun sensor	-	-

* subject to use of reinforced mounting bases on adjacent columns

** only possible on span, not on pivot

*** No physical wind sensor needed as can be set as for frost and snow during installation. Works based on the set country and zip code through an online weather server.

Styling		Back order
Classic Line	-	-
Wooddesign roof blades	✓	-
Columns		
Extra column	✓	-
Shifted column***	✓	-
Adjustable wall column	✓	-

*** Shifted column only possible on the non-pile side

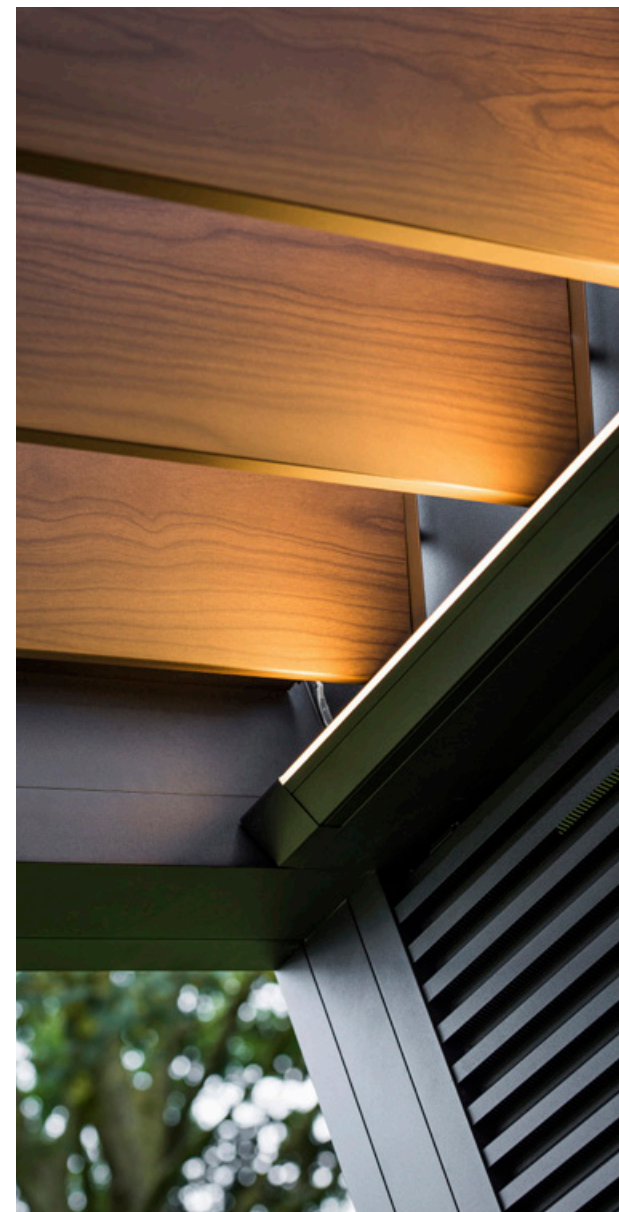

CERTIFICATES & TESTING

CE – DoP documents

- CE / UKCA / DoC / DoP / ETA

Certificates

- REACH / seaside/coastal powder coating guarantee
- RoHS / AluEco
- VMRG sun protection

Declarations

- Declaration of material codes
- Declaration of powder coating
- Declaration of anodisation layer thickness
- Declaration of glass properties
- Declaration of fire resistance / reaction
- Declaration of endurance cycles
- Declaration of safety resistance water pocket
- Declaration of electrical safety
- Declaration of asbestos
- Declaration of UV resistance / gtot + others

Test reports – calculations

- Environmental statement [recycled aluminium]
- Anchoring requirements
- Wind [load] testing / verification certificate
- Static load test / calculations

Wind guarantee of roof with blades closed	up to 160 km/h
Fixscreen wind guarantee when closed	up to 60 km/h
Wind guarantee of roof with blades closed and rotated to a vertical position (90°)	120 km/h
Wind guarantee of roof with blades retracted	160 km/h
Max. wind speed for roof or Fixscreen operation	up to 50 km/h
Water drainage flow	150 l/m ² /h
Load-bearing capacity	100 kg/m ²

Application in sandy environments

The abrasive effect of sand can cause blockages of the Skye mechanism. Therefore the application of Skye systems is not allowed at less than 200 meters from sandy environments such as sandy beaches, dunes, deserts...



CONFIGURATION

Type

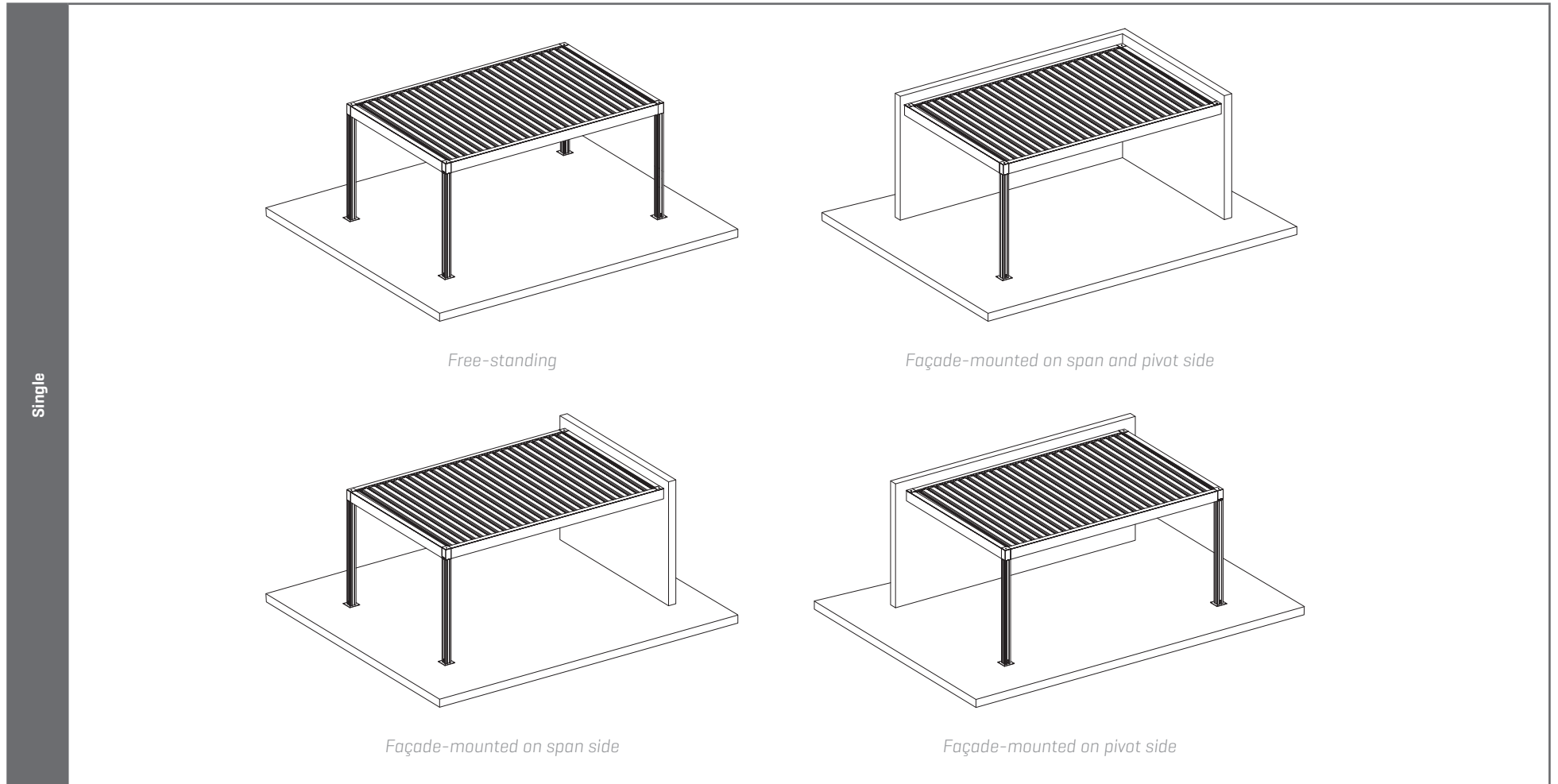

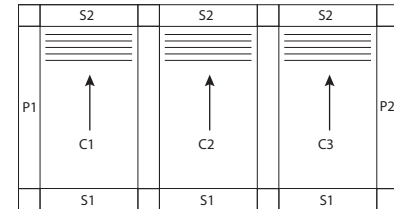
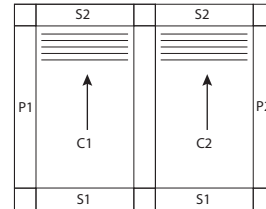

- Joined on 2 or 3 sections
- Stacking direction the same for all roof sections
- For free-standing or wall mounted types [1 or more sides]

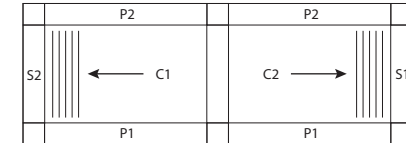
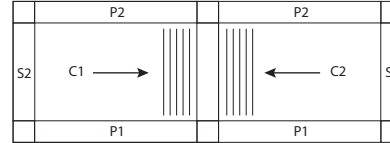
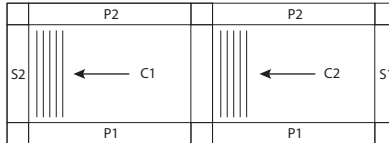

- Joined on 2 or 3 sections
- Stacking direction: same direction, towards each other, away from each other
- For free-standing or wall mounted types [1 or more sides]

The blades of the 2 roof sections rotate differently towards each other in the 2 configurations below:

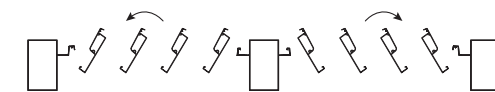
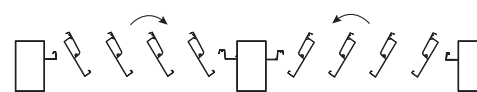
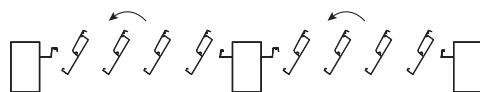
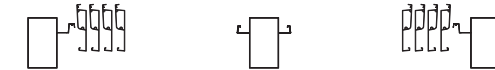
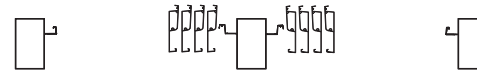
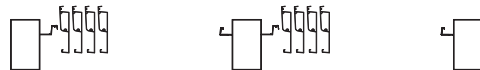
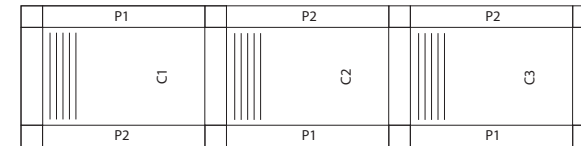

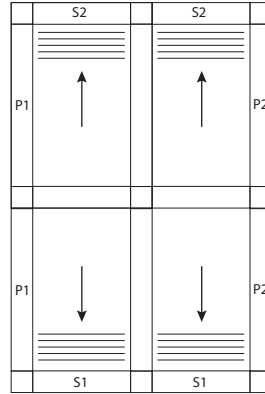
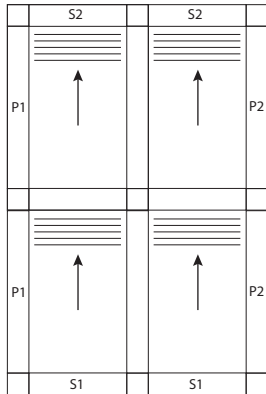

Combination Camargue / Camargue Skye is only possible in the case that all roof sections are of the same type in the span direction. Attention: in that case the coupled pivot of the Camargue part is not as wide as the coupled pivot of the Camargue Skye part, as we do not have existing profiles for that.

Construction method

Free-standing

The sides are completely separate from any walls; the cover is not mounted against any walls.

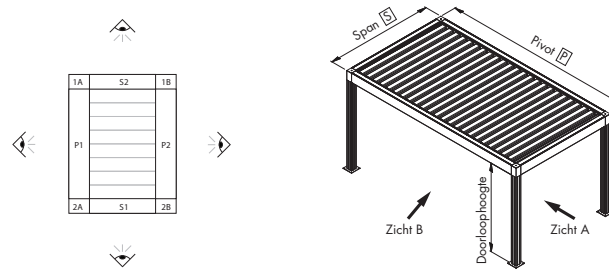

Full-length wall mounted

The full length of the side is mounted against a wall.

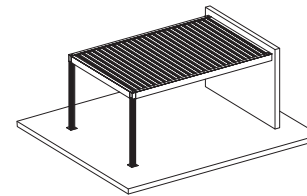
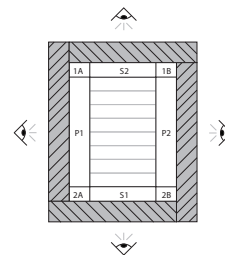

full-length wall mounted [façade mounted] on span side

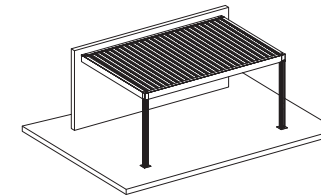

full-length wall mounted [façade mounted] on pivot side

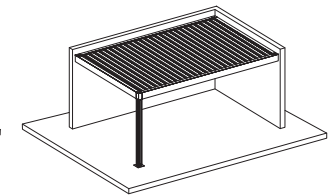

full-length wall mounted [façade mounted] on span and pivot side

Wall to the left

Only part of the side is mounted against a wall. Viewed from outside of the cover, the wall is located on the left side of the beam.

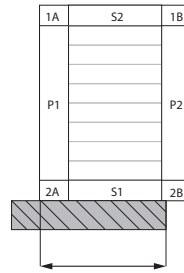

wall length

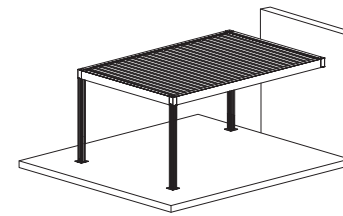

wall to the left [span]

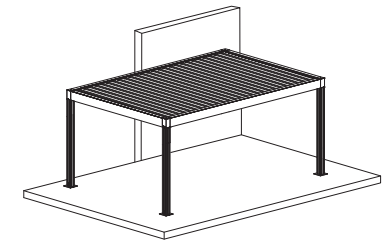

wall to the left [pivot]

Wall to the right

Only part of the side is mounted against a wall. Viewed from outside of the cover, the wall is located on the right side of the beam.

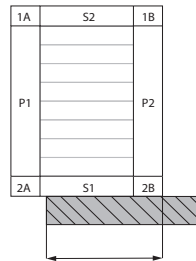

wall length

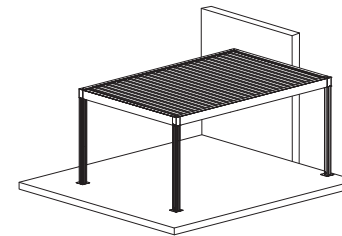

wall to the right [span]

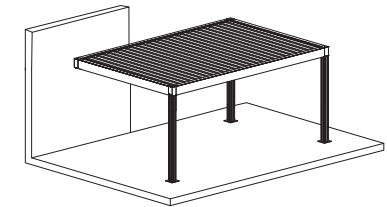

wall to the right [pivot]

Wall in the middle

A limited part of the cover is mounted against a wall. There is a free-standing section of the cover both to the left and to the right of the wall.

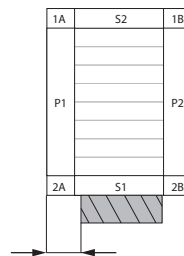

distance on the left to the wall

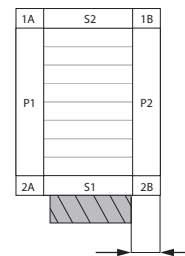

distance on the right to the wall

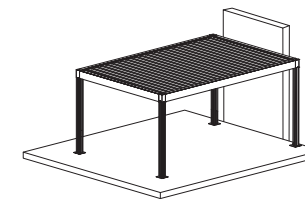

wall in the middle [span]

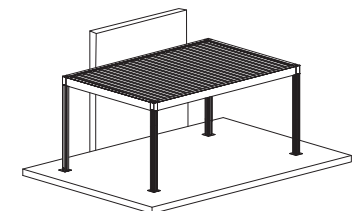

wall in the middle [pivot]

Columns

Corner column

A column is provided for each corner as standard. When installing against a wall that guarantees sufficient stability, the column on this side may be omitted.

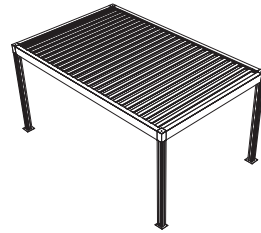

Shifted column

A column may be shifted in the direction of the pivot to a maximum of 1/5 of the pivot length. This guarantees the stability of the construction at all times.

A shifted column in Camargue and Camargue Skye is entered by entering the required distance from the corner. It is not possible to shift a column in the span direction. Shifted column cannot be on S2.

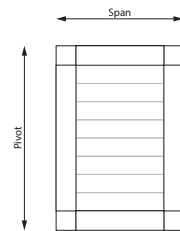
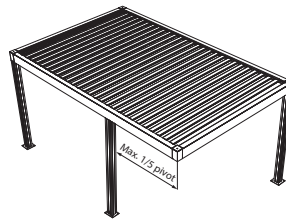

Adjustable wall column

When installing Fixscreens at a right angle to a façade, a column must be fitted.

Given the fact that outside walls are not always built perfectly plumb, a visually disruptive opening may form between the wall and the column. An adjustable wall column guarantees a flush connection front and compensates for an angle of 1cm to the front or 1cm to the rear.

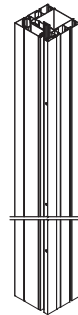
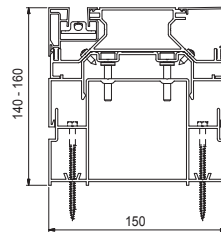

Shorter/longer columns

A column that is longer (positive overlength) or shorter (negative overlength) than the entered passage height may be ordered. Opting for a positive overlength can be useful to keep a roof perfectly level when your patio slopes downward, for example. Alternatively, if one of the columns is to be installed on a small wall, for example, it can be shortened (negative overlength).

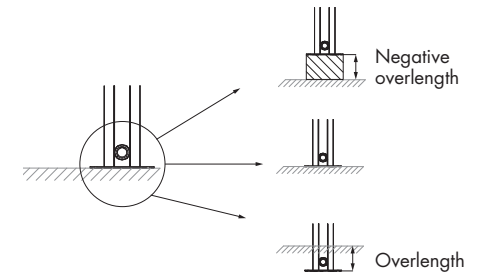
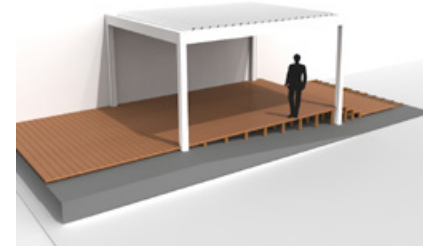

Positive overlength is possible up to the maximum passage height [2800 mm] plus 500 mm [3300 mm].

Negative overlength is possible up to the minimum passage height [= 500 mm].

Overlength only affects the price if the column length >3000 mm.

Additional column

By adding an additional column, one side of the covering is divided into two parts. The position of the additional column is always viewed from side P1 [additional column on span] or S1 [additional column on pivot].

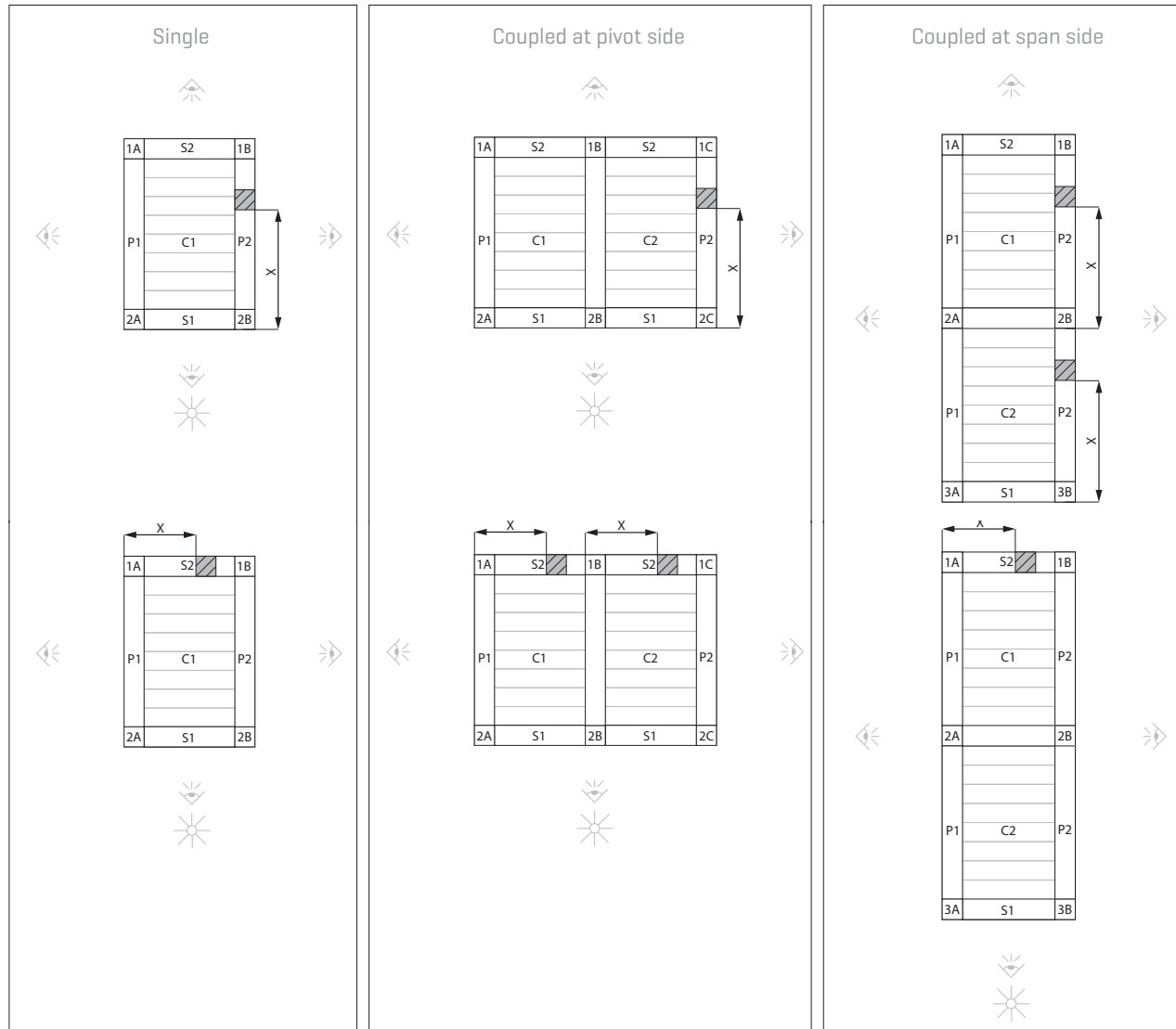
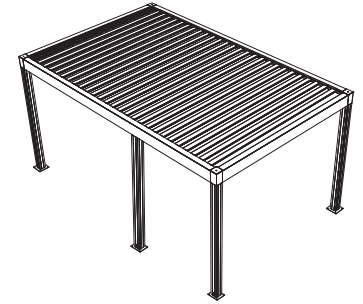

X = position of the intermediate column [mm]

Profiles

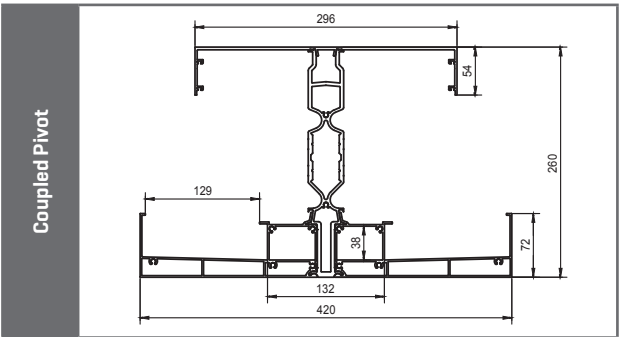
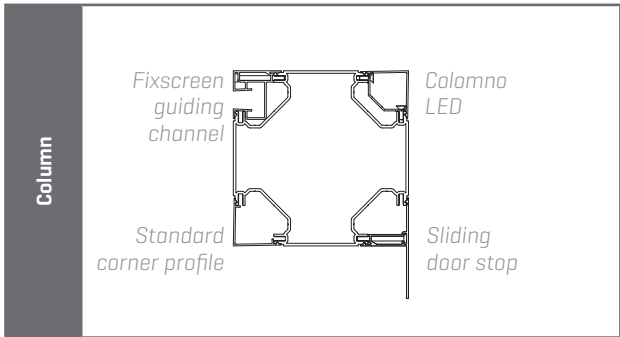
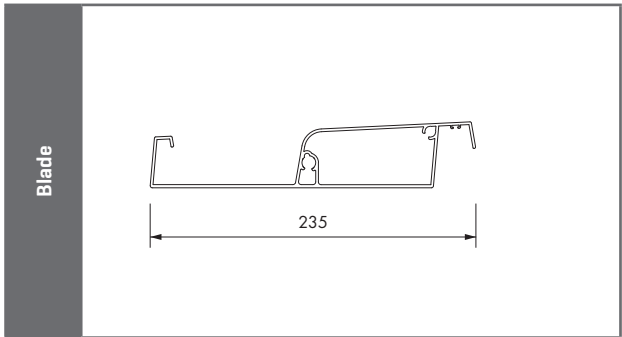
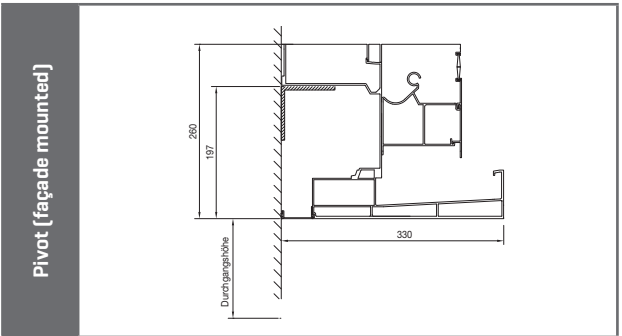
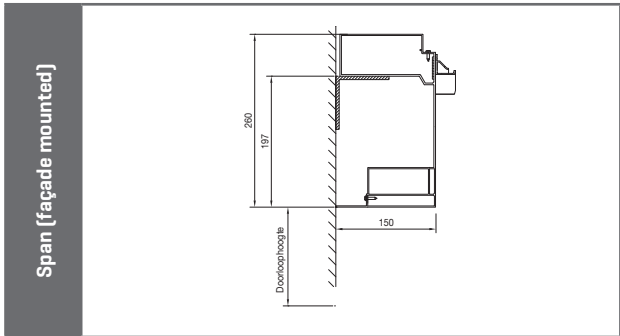
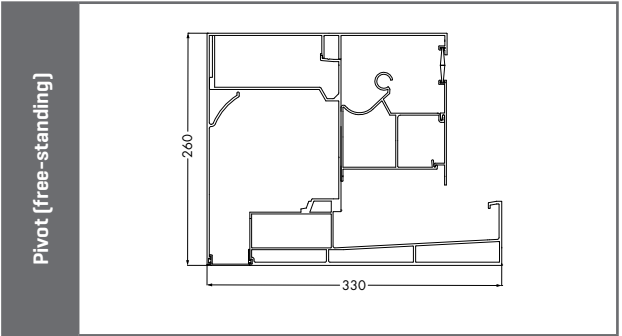
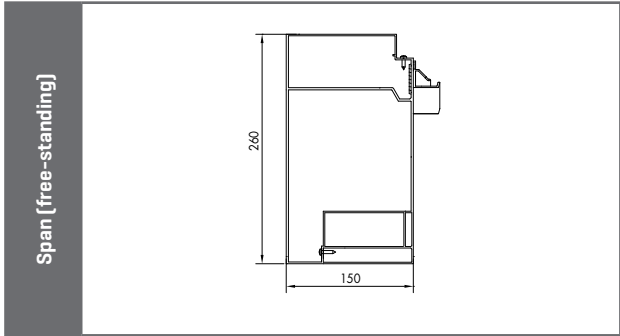
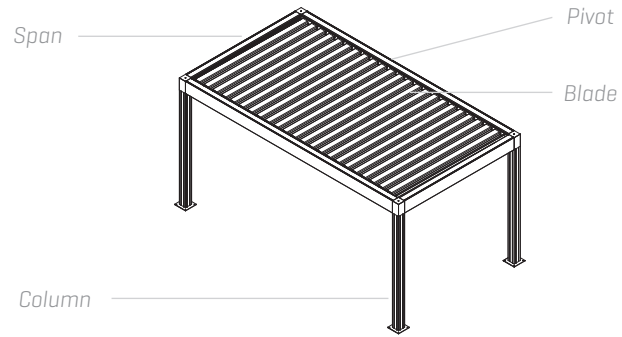

Blade orientation

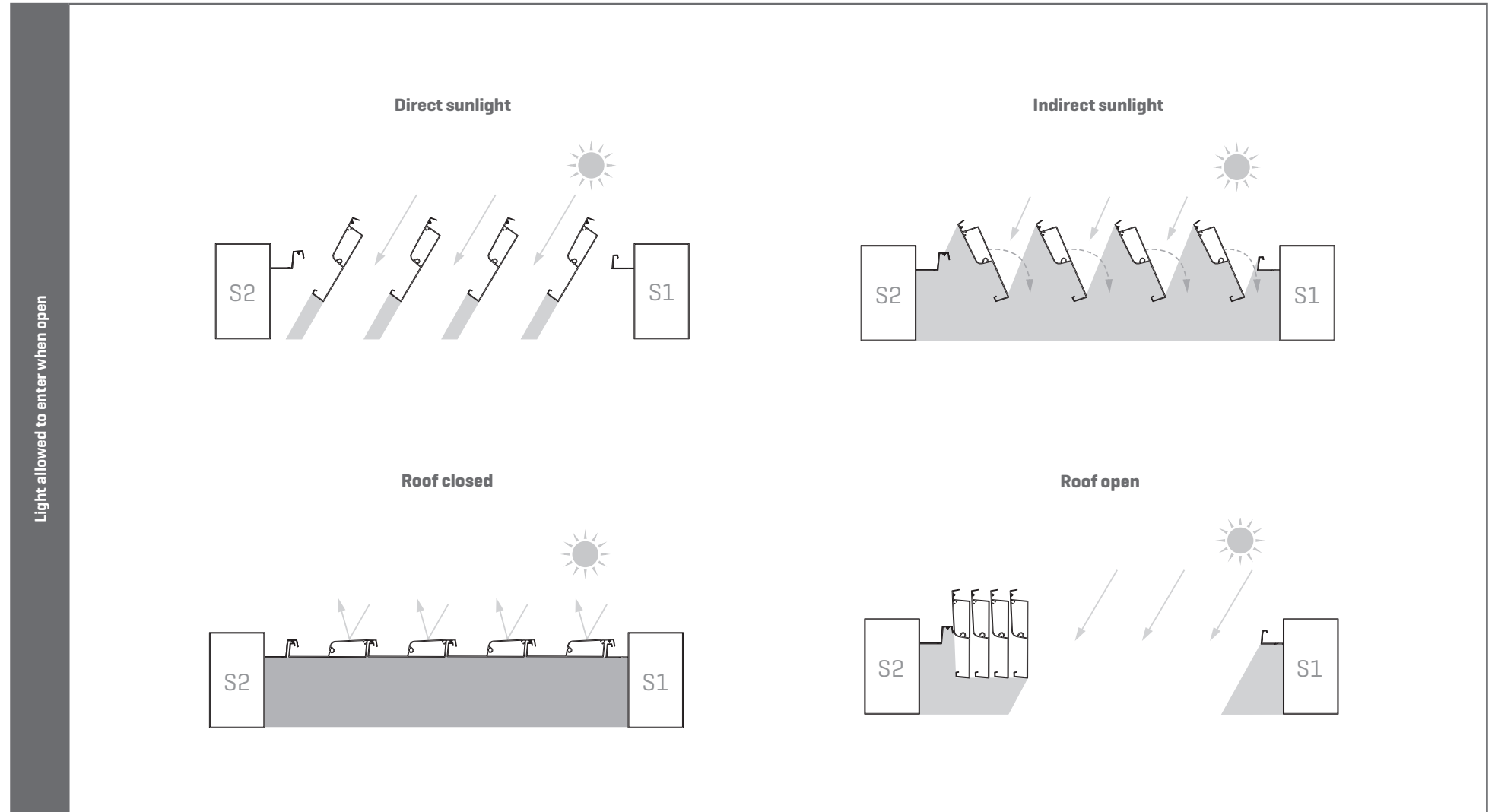

Mounting bases

The strength requirements determine whether or not reinforced mounting bases are needed.

Standard mounting bases

For use in normal circumstances, without increased wind load.

- Base plate thickness: 6 mm
- Core length: 300 mm
- Visible base plate: 270 x 270 mm

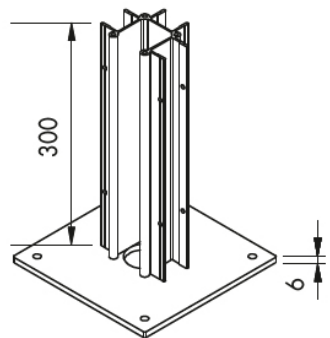

Reinforced mounting bases

At locations with increased wind loads, the cover must be equipped with reinforced mounting bases to guarantee the stability of the structure.

Examples include coastal areas, installation at a height or on a rooftop terrace.

- Base plate thickness: 10 mm
- Core length: 1495 mm
- Visible base plate: 270 x 270 mm

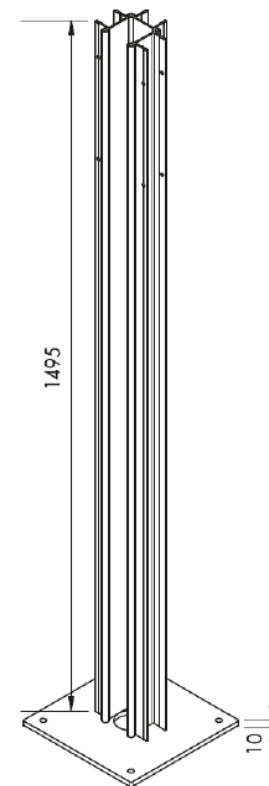

Mounting bases

The choice of reinforced or non-reinforced mounting bases will be made automatically based on the strength requirements and/or side insert selection. You can select a finish for your mounting bases from the possible options below.

				
Type	Visible mounting base		Invisible mounting base	
Application	Not against a structure	Pivot or span against a structure	All applications	
Non-reinforced mounting base	Available at standard price			
Reinforced mounting base	Available at a surcharge			Not available

Water drainage



Water will be drained down an integrated drainpipe in the columns of your choice. Starting at 16 m², a minimum of two drainage outlets must be provided for each roof section, of which at least one drain must be on the lowest side of the blades (not on the motor side). For all other dimensions, at least one drain must be arranged on the lowest side of the blades (not on the motor side).

Please note!

If there is only one water-draining column and the surface area is greater than 16 m², the drainage capacity of the roof will only be 90 litres per hour (0.025 L/m².s).

Three options for the height of the drainpipe:

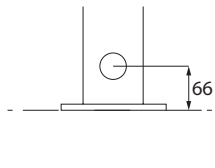
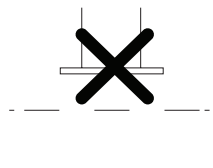
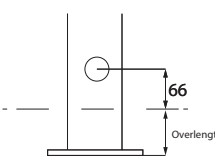
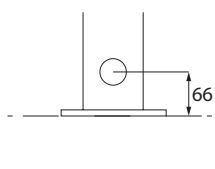
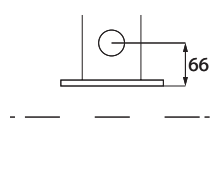
- 66 mm relative to bottom side of the base regardless of whether or not overlength is applicable. [standard]
- 66 mm + overlength relative to bottom side of the base. In case of overlength, you can choose to have the overlength size included in the standard distance of 66 mm. For example: an overlength of 100 mm means water drainage at 166 mm relative to the bottom side of the mounting base.
- Variable height
Minimum distance above ground level = 40 mm.
Maximum distance = passage height - 415 mm.
The height is always measured from the bottom of the mounting base to the centre of the drainage hole.

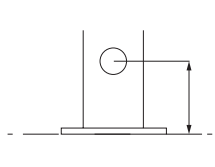
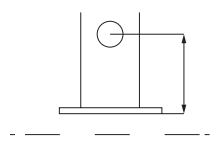
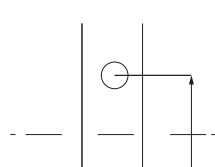
	Passage height	Negative overlength	Positive overlength
66 mm relative to bottom side of base [standard]			
66 mm + overlength relative to bottom side of base			
Variable height (mm)			

OTHER TOOLS

Want to find out more? Visit the Professional Portal on our website (www.renson.eu) to access the following tools.

- Technical drawings
- Training documents
- Installation manual
- User manual
- [Digital photo book & social media](#)
- ...

