



atriadesigns.ca
604-428-1818
sales@atriadesigns.ca

NEW

TWIST

The ergonomic centre-pole parasol



Glatz 

TWIST



Frame	6 or 8 parts Pole Ø 45 mm Premium design Function: All the operating functions at waist level: open/close using a crank, tilt to 32° using a rotary handle, for 360° rotation using a clamping lever Canopy self-tensing through flexible rib ends Frame roof: round, square, rectangular Fabric corners reinforced with leather (Fabric quality 5, 4)
Frame colour	Matt white or anthracite powder-coated aluminium
Canopy	Fabric quality 5: polyacrylic, 300 g/m ² , UV protection > 98 % Fabric quality 4: polyester, 250 g/m ² , UV protection > 98 % Fabric quality 2: polyester, 220 g/m ² , UV protection > 98 %, (Only available on the previous model)
Flounce	Only available without
Protective cover	Can be ordered as an optional extra
Accessories	Lower pole with height adjustment
Electrical accessories	Osyron Spot LED with integrated battery pack

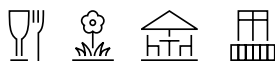

Using Locations

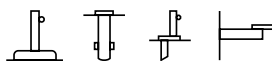

Fixations



TWIST,
© Int. Patents pend.



Swiss
Design

Assortment

	Nominal size without flounce	Number of ribs	Order no. Frame matt white	Order no. Frame anthracite
○	cm			
	Ø 270	8 parts	207 00 270 161	207 00 270 301
	Ø 300	8 parts	207 00 300 161	207 00 300 301
	Ø 330	8 parts	207 00 330 161	207 00 330 301
□	240×240	8 parts	207 00 241 161	207 00 241 301
□	210×150	6 parts	207 00 212 161	207 00 212 301
	250×200	6 parts	207 00 252 161	207 00 252 301

Nominal size	Lateral distance	Pole Ø	Area covered	Height closed	Crank height	Clear headroom/ inclined	Total height/ inclined	Foundation	Minimum weight for base	max. wind speed open perm.
cm	cm	cm	m ²	cm	cm	cm	cm	cm	kg	km/h (wind force)
A	AS	M	B	E	D	F/K	G/L	C		
Ø 270	250	4.5	5.2	100	90	205/130	235/275	50×50	40	55 (7)
Ø 300	275	4.5	6.4	90	90	205/120	240/280	60×60	40	50 (7)
Ø 330	305	4.5	7.7	75	90	205/115	240/290	60×60	55	45 (6)
240×240	-	4.5	5.8	70	90	205/135	240/265	50×50	40	45 (6)
210×150	-	4.5	3.2	105	90	205/160	230/245	50×50	30	55 (7)
250×200	-	4.5	5.0	80	90	205/150	240/255	50×50	40	45 (6)

The listed measures represent extrapolated average values that may be slightly different on the product (± 2% ± 5 cm).

Traditionally, the nominal dimension is calculated by doubling the rib length. For this reason, the nominal dimension can exceed the specified tolerance range.

Height dimensions are based on ground socket BT. These vary slightly depending on the type of base. Except for steel base minus 5 cm.

The max. wind speed limits as per our separate sheet apply only if the parasol canopy is in a horizontal position and if there is a fix ground anchorage.

In the presence of several parasols, the minimum distance between one parasol and another and between parasols and walls shall be 20 cm.

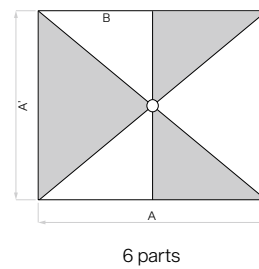
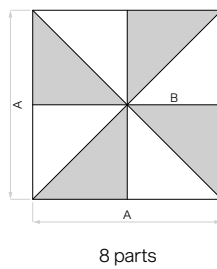
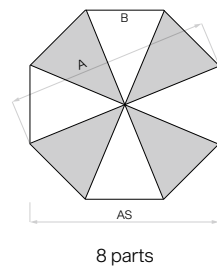
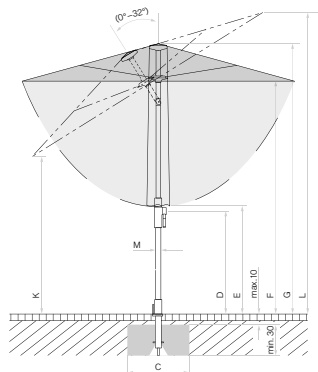

Loose cover max. 10 cm, concrete thickness
min. 30 cm (pay attention to frost depth),
Guarantee water drainage

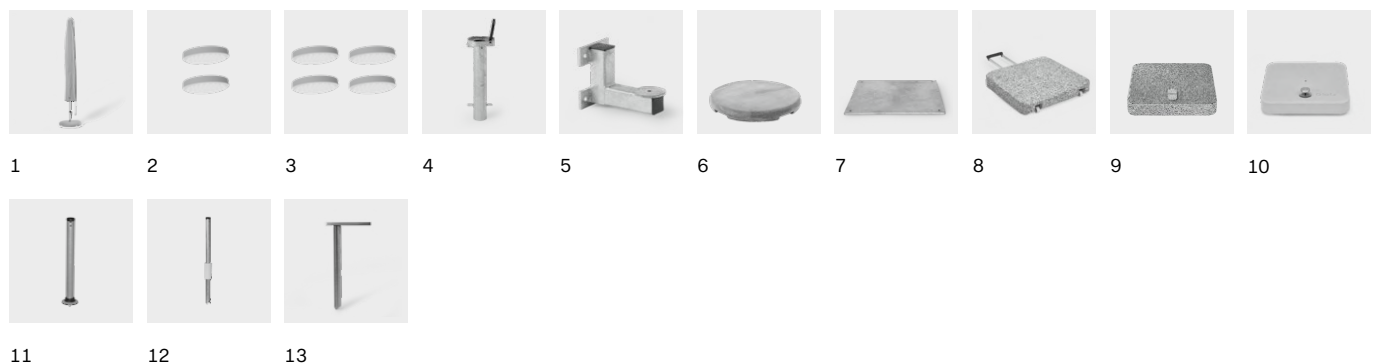

Accessories		Absolutely necessary	Order no.
Protective cover made of coated, tear-resistant polyester fabric			
1	Protective cover with zip and rod		350 01 609 980
	10 pieces, protective cover with zip and rod		350 01 609 974
Electrical accessories			
2	OSYRION Spot LED battery-powered light, set of 2, with remote control, including charger		350 01 563 000
3	OSYRION Spot LED battery-powered light, set of 4, with remote control, including charger		350 01 563 100
Fixations			
Ground sockets			
4	Ground socket BT, galvanised steel	Connection tube BT	350 01 206 100
Wall consoles			
5	Wall bracket Z, 180 mm, galvanised steel	Support tube Z	350 01 205 000
Bases			
6	Concrete base Z, 30 kg, Ø 47×8.5 cm	Support tube Z	350 01 109 532
6	Concrete base Z, 40 kg, Ø 60×8.5 cm	Support tube Z	350 01 109 529
	1 pallet (20 pieces) concrete base Z, 40 kg, Ø 60×8.5 cm	Support tube Z	350 01 109 533
6	Concrete base Z, 55 kg, Ø 60×11 cm	Support tube Z	350 01 109 528
	1 pallet (20 pieces) concrete base Z, 55 kg, Ø 60×11 cm	Support tube Z	350 01 109 534
7	Steel base Z 40 kg, 58.5×58.5×2 cm, galvanised steel	Support tube Z	350 01 100 210
	Add-on weight 30 kg, 57.5×57.5×1.7 cm, galvanised steel		350 01 100 310
Bases with castors			
8	³ Natural granite base Z, 40 kg, 45×45×8 cm, natural stone, with castors and retractable handle	Support tube Z	350 01 109 465
8	³ Natural granite base Z, 55 kg, 55×55×9 cm, natural stone, with castors and retractable handle	Support tube Z	350 01 109 445
9	³ Base with castors Z, 55 kg, 65×65×11 cm, light concrete (without decorative plate) NEW	Support tube Z + Decorative plate	350 01 110 000
	Decorative plate in grey for base with castors Z, 55 kg, plastic NEW		350 01 110 110
	Decorative plate in anthracite for base with castors Z, 55 kg, plastic NEW		350 01 110 120
	Decorative plate in sand for base with castors Z, 55 kg, plastic NEW		350 01 110 130
10	^{1,3} Base with castors Z, 55 kg, 65×65×11 cm, cast concrete decor	Support tube Z	350 01 102 900
	^{1,3} 1 pallet (5 pieces) base with castors Z, 55 kg, Ø 65×65×11 cm, cast concrete decor	Support tube Z	350 01 102 950
Support tubes/Connection tubes			
11	Support tube Z, internal, Ø 40/37 mm, galvanised steel NEW		350 01 201 610
12	Connection tube BT, internal, Ø 40/37 mm, galvanised steel, incl. cover matt white NEW		350 01 201 816
	Connection tube BT, internal, Ø 40/37 mm, galvanised steel, incl. cover anthracite NEW		350 01 201 830
Lower pole			
	Lower pole with height adjustment to 25 cm, matt white NEW		350 01 902 716
	Lower pole with height adjustment to 25 cm, anthracite NEW		350 01 902 730
Various fixation types			
13	Lawn spike Z, 85×150×350 mm, galvanised steel	Support tube Z	350 01 205 400

¹ while stocks last

³ only suitable for smooth, joint free surface coverings





Glatz AG
Parasols
2023 Season

[glatz.com](https://www.glatz.com)

